

# TYRE CATALOGUE

OFF THE ROAD & INDUSTRIAL

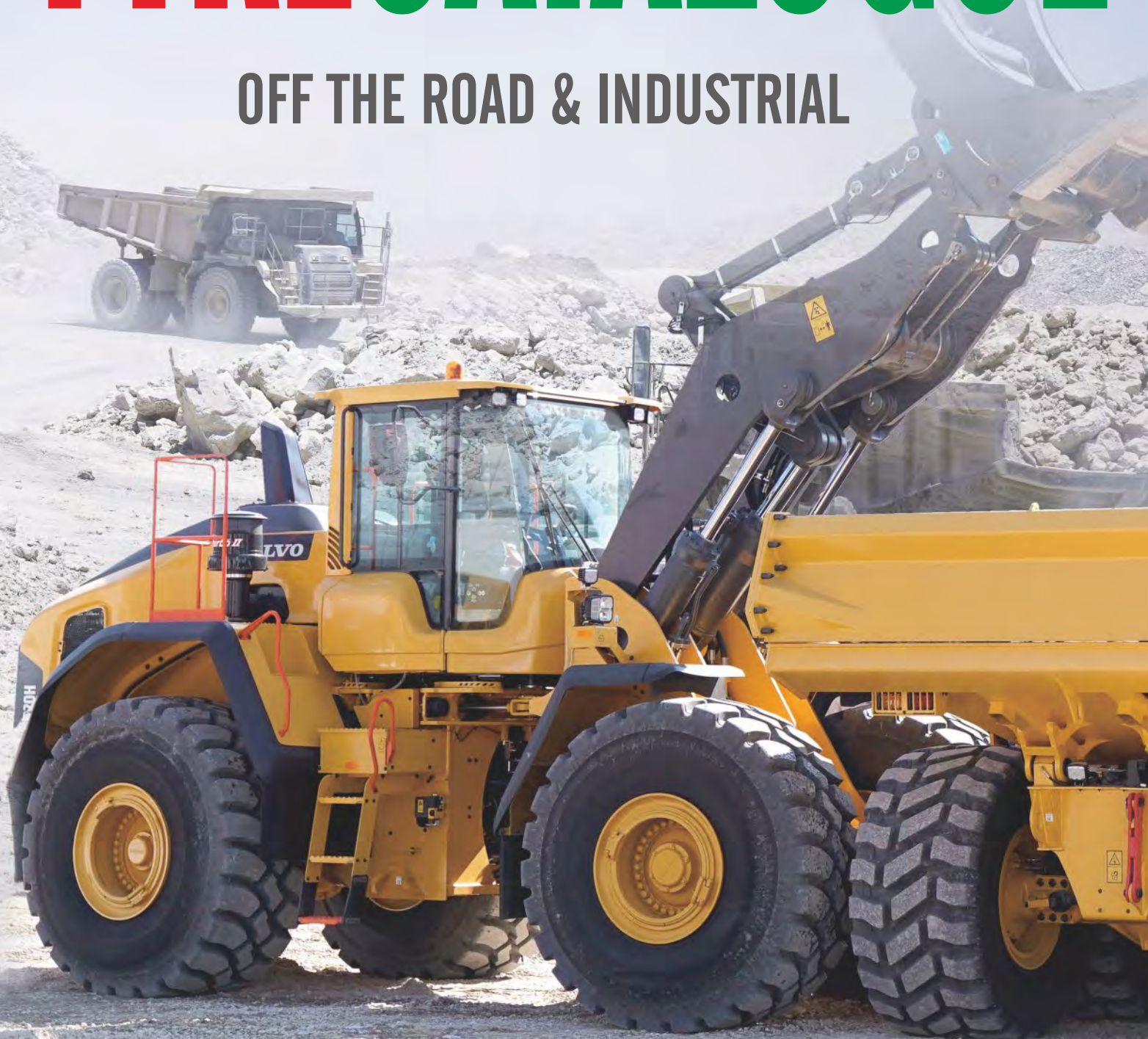



# CONTENTS

**General Information** 05-10

**Tyre Tread Summary** 11-12

**Off-The-Road Tyres-Radial** 13-47

Loader / Earthmover / Grader	13
Cranes	27
Straddle/Terminal Tractor	31
Rigid Dump Truck	36
Underground Mining Tyre	46

**Off-The-Road Tyres-Bias** 48-87

Loader / Earthmover / Grader	48
Underground	54
Compactor	56
Dump Truck	58
Desert Application	63
Backhoe	65
Special Machines	70
Logger	72
Skid Steer	74
Port Service	78
Industrial Service-Forklift	83

**Off-The-Road Tyres-Solid** 88-98

Resilent	88
Press On	96

**Load & Inflation Pressure Table** 99-102

**Radial OTR Range According To Rim** 103-106

# Enterprise Introduction



- A Company Established in Year 1958
- No. 1 Tyre Manufacturer in China
- No. 8 of Top 75 Global Tyre Manufacturers in Year 2022
- Sale Revenue Reached USD4.5 Billion in Year 2021

Zhongce Rubber Group Co., Ltd (ZC RUBBER) is a global tyre company based in Hangzhou, China and was founded in 1958. Over our more than 60 years of history, we experienced continuous growth in quality and reputation to become the Top 10 tyre manufacturer worldwide today.

Our engineers with our international R&D team focus on constant technological development and innovation spending millions of US dollars in research and development each year and upgrading our production and testing facilities. The ET Industrial Brain in the production process promises our smart production and guarantee tires with high quality, safety, and value with maximum efficiency.

We have formed an extensive global service network of about 1,200 distributors with 250,000 sales locations in 160 countries. Our subsidiaries in Thailand, Germany, Brazil, and the United States serve customers without any difference in time and language. We are dedicated to better support our suppliers, distributors, and customers through a one-stop service.

Safe and Value are always the key of our company. We take pride in the superior quality of our tyre products and the first-rate services. We are still endeavoring to become one of the most respected tyre manufacturers globally and craft a better future with all partners and friends.



China Compulsory Certification



US DOT Certification



European E-MARK Certification



SNI Certification of Indonesia



BIS Certification of India



INMETRO Certification of Brazil



# General Information

## Tyre Specification Code

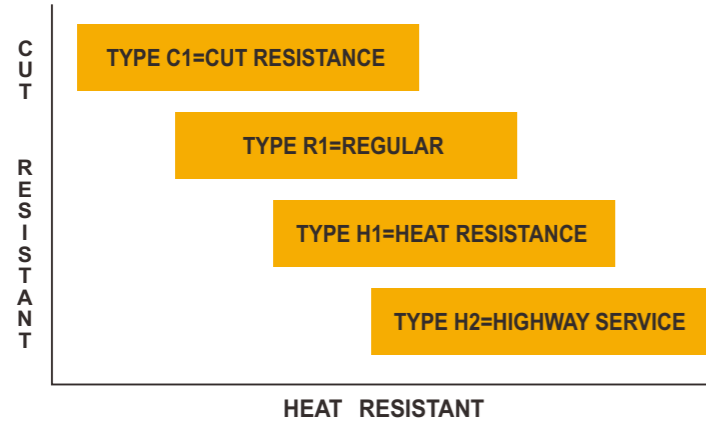

ZC rubber tyre follows the below Tyre Specification Code on it.

	E-Spec./L-spec			Highway
	C1	S1	H1	H2
385/95R24				●
385/95R25				●
445/95R25				●
520/80R25				●
14.00R24	●			
16.00R24	●			
13.00R25	●			
14.00R25	●			
15.5R25	●			
17.5R25	●			
20.5R25	●			
23.5R25	●			
26.5R25	●			
29.5R25	●			
18.00R33	●	●	●	
21.00R35	●	●	●	
24.00R35	●	●	●	
27.00R49	●	●	●	

H1 compound can be available upon request for earthmover application

## Tyre Sidewall Instruction

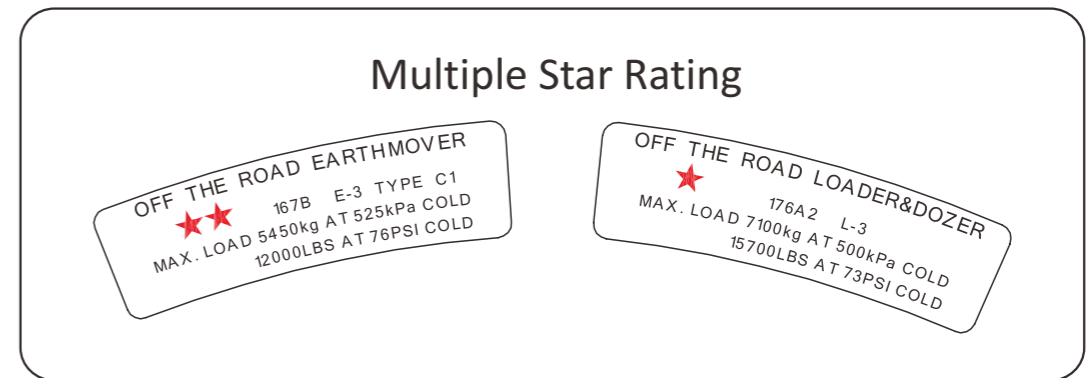
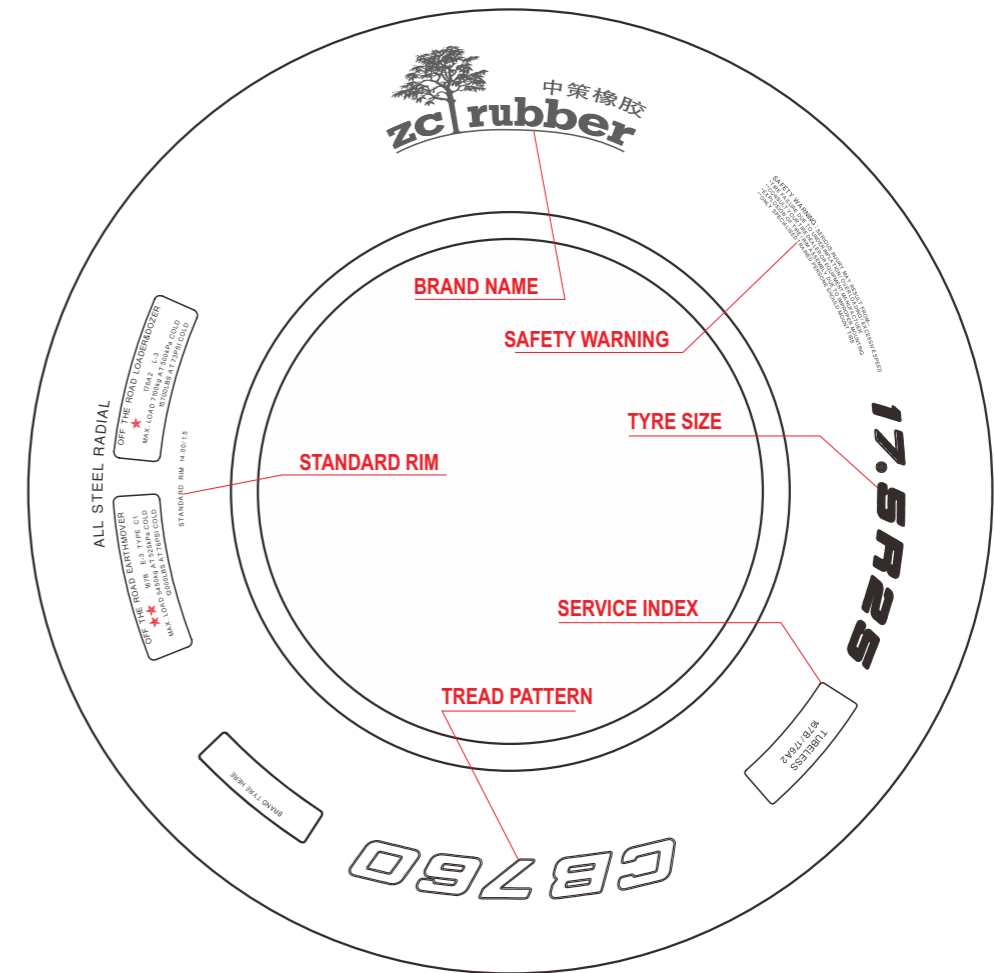

Some of Radial OTR tyres have dual specification codes which can be used for both services, which we call: Multiple Star Rating

# General Information

## Tyre Sidewall Instruction

### Service Classification

ZC rubber tyre has code number on it in order to identify and serve the function.

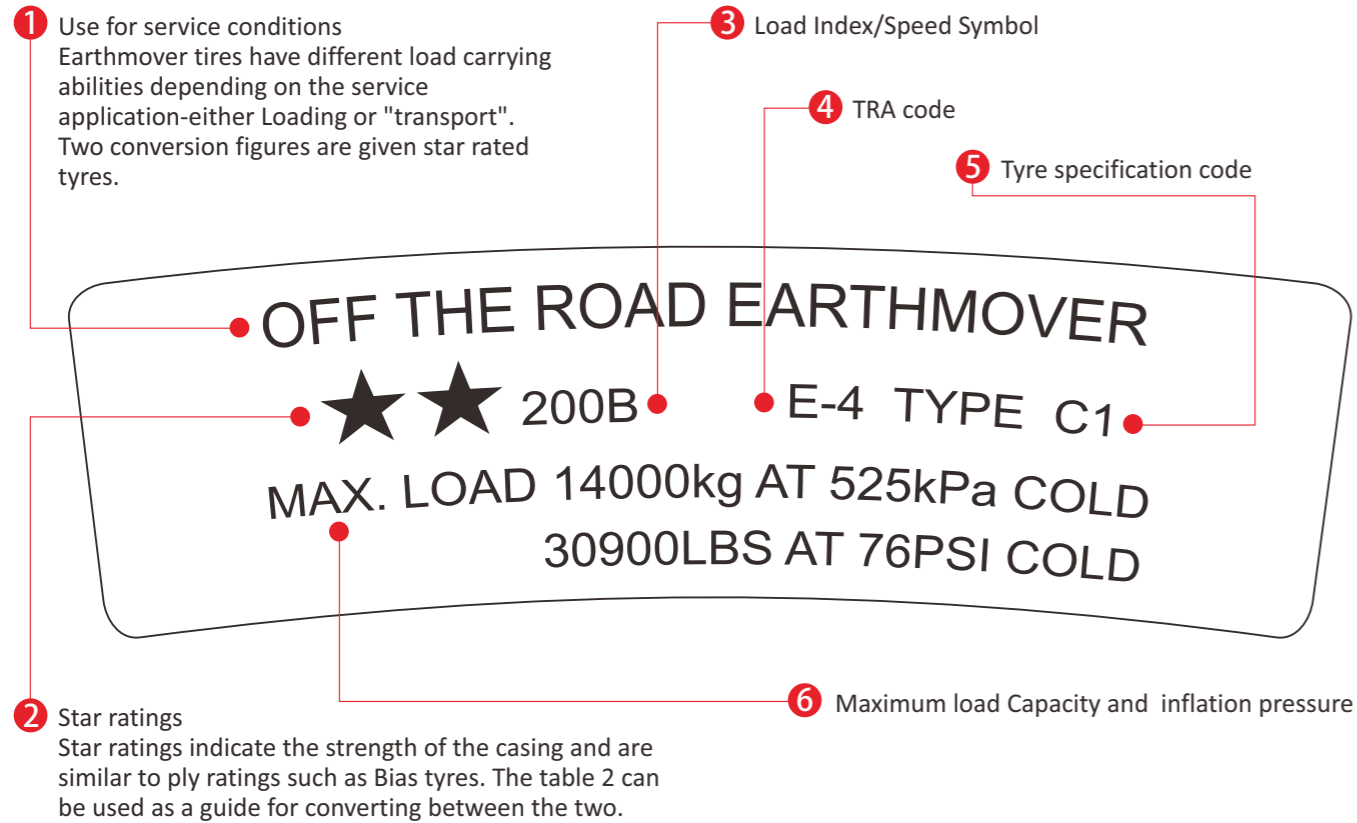

## Conversion table: Star rating to Ply ratings

Loader/Dozer			Earthmover			Grader		
Tyre Size	Star Mark	Ply Rating	Tyre Size	Star Mark	Ply Rating	Tyre Size	Star Mark	Ply Rating
15.5R25	★	UPTO16PR	17.5R25	★★	UPTO16PR	13.00R24	★	UPTO16PR
17.5R25	★	UPTO16PR	20.5R25	★★	UPTO24PR	14.00R24	★	UPTO16PR
20.5R25	★	UPTO24PR	23.5R25	★★	UPTO24PR	16.00R24	★	UPTO16PR
23.5R25	★	UPTO24PR	26.5R25	★★	UPTO24PR			
26.5R25	★	UPTO24PR	29.5R25	★★	UPTO28PR			
29.5R25	★	UPTO28PR	14.00R25	★★	UPTO32PR			
			18.00R33	★★	UPTO40PR			
			21.00R35	★★	UPTO44PR			
			24.00R35	★★	UPTO48PR			
			27.00R49	★★	UPTO54PR			

## Identification of OTR Tyres

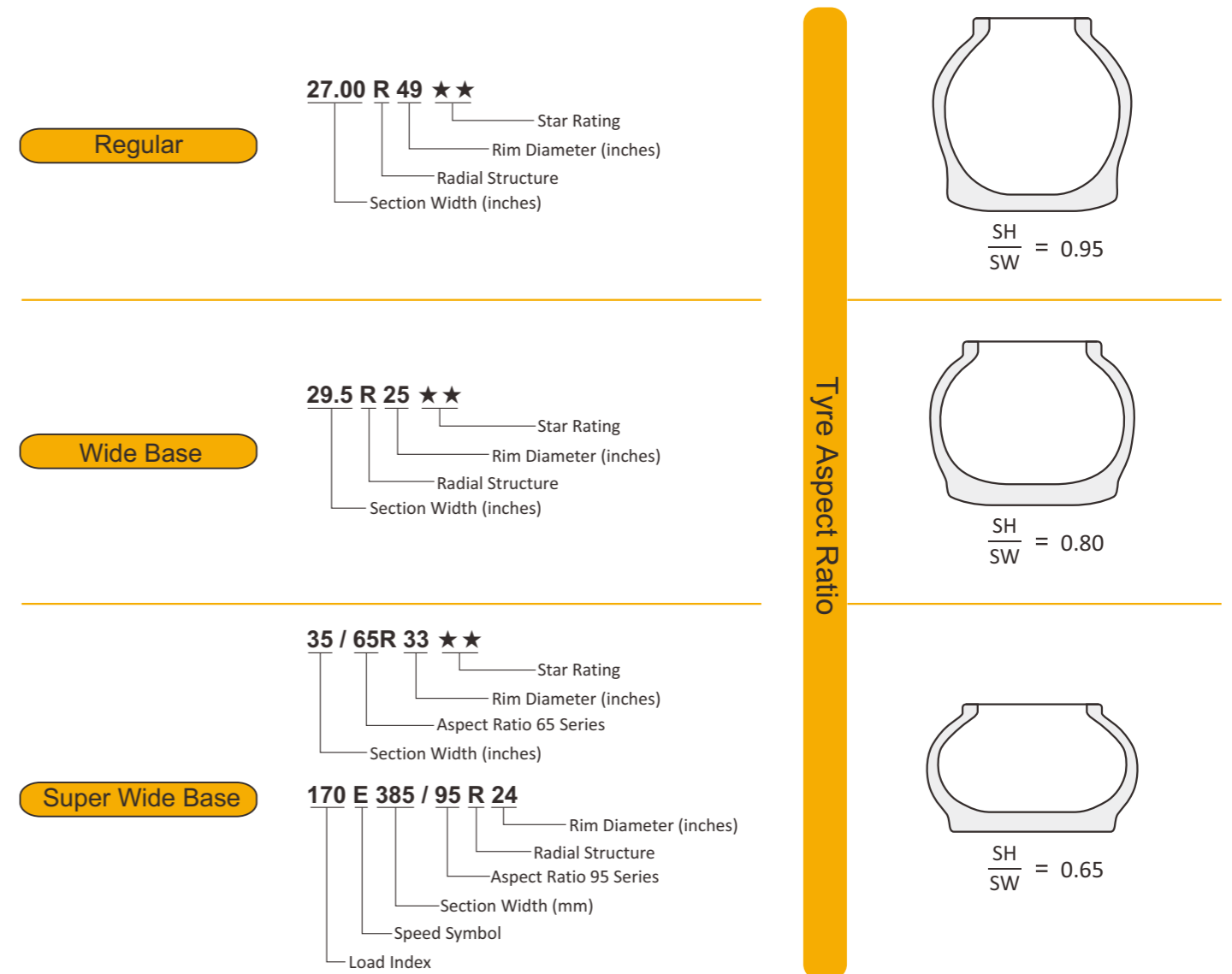

## Comparison of Tread Depth

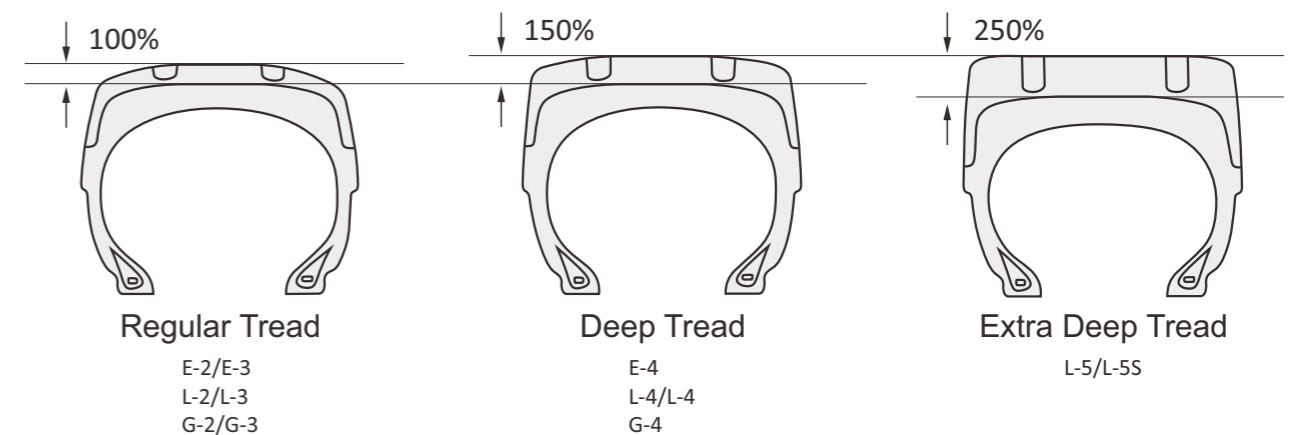

# General Information

## Load Index

The LOAD INDEX is a numerical code with the maximum carrying load capacity.

Load Index	kg	lbs	Load Index	kg	lbs	Load Index	kg	lbs	Load Index	kg	lbs
120	1400	3085	148	3150	6940	176	7100	5700	204	16000	35300
121	1450	3495	149	3250	7160	177	7300	16100	205	16500	36400
122	1500	3305	150	3350	7390	178	7500	16500	206	17000	37500
123	1550	3415	151	3450	7610	179	7750	17100	207	17500	38600
124	1600	3525	152	3550	7830	180	8000	17600	208	18000	39700
125	1650	3640	153	3650	8050	181	8250	18200	209	18500	40800
126	1700	3750	154	3750	8270	182	8500	18700	210	19000	41900
127	1750	3860	155	3875	8540	183	8750	19300	211	19500	43000
128	1800	3970	156	4000	8820	184	9000	19800	212	20000	44100
129	1850	4080	157	4125	9090	185	9250	20400	213	20600	45400
130	1900	4190	158	4250	9370	186	9500	20900	214	21200	46700
131	1950	4300	159	4375	9650	187	9750	21500	215	21800	48100
132	2000	4410	160	4500	9920	188	10000	22000	216	22400	49400
133	2060	4540	161	4625	10200	189	10300	22700	217	23000	50700
134	2120	4675	162	4750	10500	190	10600	23400	218	23600	52000
135	2180	4805	163	4875	10700	191	10900	24000	219	24300	53600
136	2240	4940	164	5000	11000	192	11200	24700	220	25000	55100
137	2300	5070	165	5150	11400	193	11500	25400	221	25750	56800
138	2360	5205	166	5300	11700	194	11800	26000	222	26500	58400
139	2430	5355	167	5450	12000	195	12150	26800	223	27250	60100
140	2500	5510	168	5600	12300	196	12500	27600	224	28000	61700
141	2575	5675	169	5800	12800	197	12850	28300	225	29000	63900
142	2650	5840	170	6000	13200	198	13200	29100	226	30000	66100
143	2725	6005	171	6150	13600	199	13600	30000	227	30750	67800
144	2800	6175	172	6300	13900	200	14000	30900	228	31500	69400
145	2900	6395	173	6500	14300	201	14500	32000	229	32500	71700
146	3000	6610	174	6700	14800	202	15000	33100	230	33500	73900
147	3075	6780	175	6900	15200	203	15500	34200	231	34500	76100

## Speed Symbol

The SPEED SYMBOL indicates the speed at which the tire can carry a load corresponding to its Load Index under service specified conditions.

Speed Symbol	Speed (km/h)	Speed Symbol	Speed (km/h)
A1	5	B	50
A2	10	C	60
A3	15	D	65
A4	20	E	70
A5	25	F	80
A6	30	G	90
A7	35		
A8	40		

## ZC-RUBBER TYRE FEATURES

- Special Tread design for all applications
- Durability of tyres
- Strong tyre casing for retread
- Cool running tires helping to save fuel
- Eco-friendly product and REACH conformity
- ISO 9001 certified production

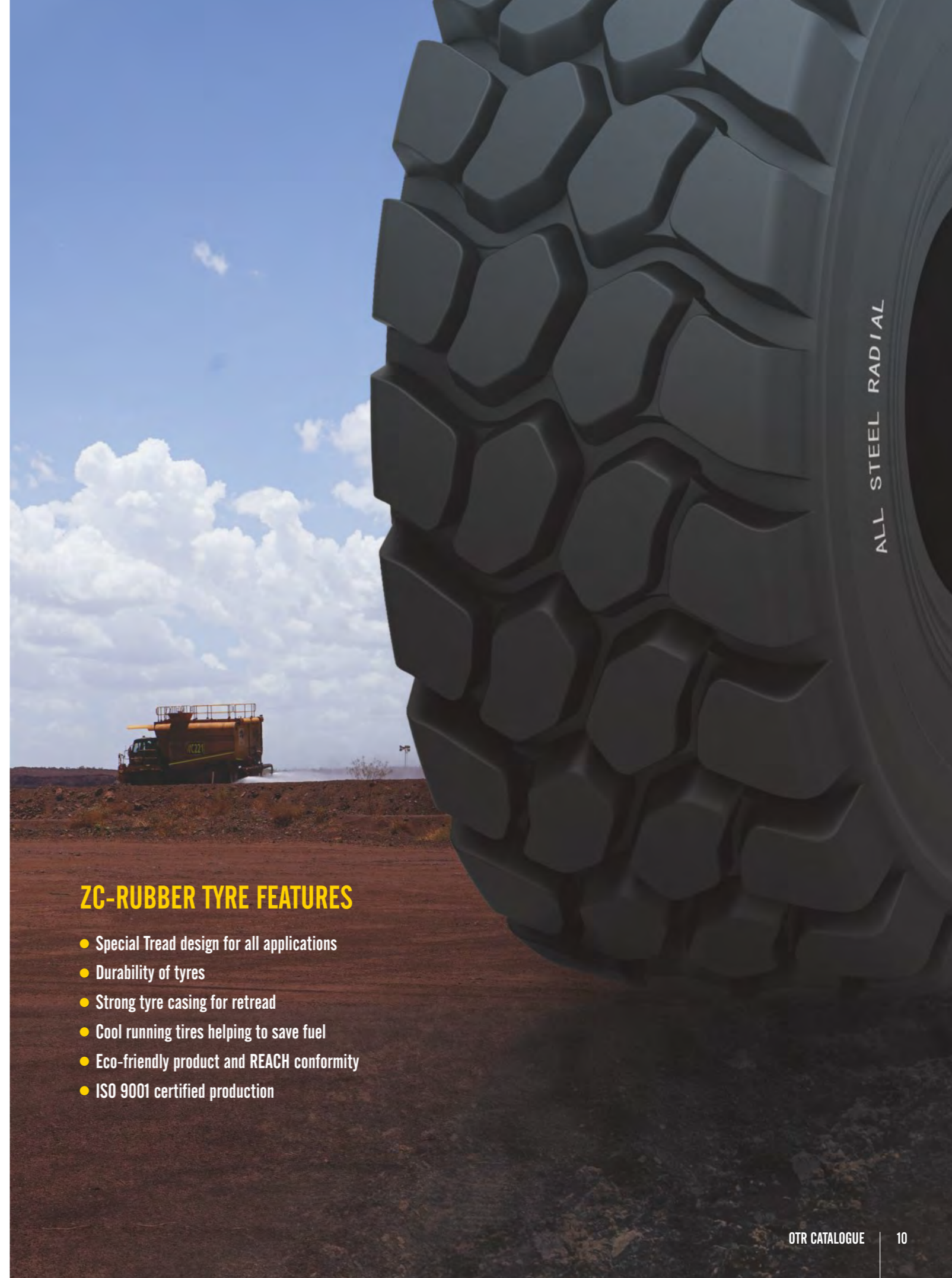

# Tyre Tread Summary

## Off-The-Road Tyres-Radial



## Off-The-Road Tyres-Bias



## Off-The-Road Tyres-Solid





# OFF-THE-ROAD TYRES-RADIAL

## CB760

Loader / Earthmover / Grader

- ▮ Specially designed non-directional tread pattern offers extra gripping power
- ▮ Longer tread life due to the deeper tread depth and unique tread compound
- ▮ New sidewalls are shaped to minimize damage from cutting
- ▮ Optimised Retreading Ability because of the robust casing



Size	TRA Code	Ply Rating	Service Index	Standard Rim	Tread Depth (mm)	Tread Depth (32nd)	TT/TL
17.5R25	E-3/L-3	★★	167B	14.00/1.5	27.0	34	TL
			182A2				
20.5R25	E-3/L-3	★★	177B	17.00/2.0	28.5	36	TL
			193A2				
23.5R25	E-3/L-3	★★	185B	19.50/2.5	35.5	45	TL
			201A2				

\* Multiple Star Rating



# OFF-THE-ROAD TYRES-RADIAL Loader / Earthmover / Grader

With its unique technology, ZC Rubber Group develops full range of Loader Earthmover Grader Tyres, 60 years experience of tyre design and production offer us great advantage in understanding the rubber, the steel, the carbon black and customer demand

The range of ZC Rubber Group tyres provides you with an one stop solution adapted to your work







## CB761

Loader / Earthmover / Grader

- Classical design with high resistance to impacts and cuts
- Longer tread life due to the deeper tread depth
- New sidewall design for enhanced reinforcement and protection
- Optimised Retreading because of the robust casing

Size	TRA Code	Ply Rating	Service Index	Standard Rim	Tread Depth (mm)	Tread Depth (32nd)	TT/TL
15.5R25	L-3	★	169A2	12.00/1.3	26.0	33	TL
20.5R25	E-3/L-3	★★	177B 193A2	17.00/2.0	33.0	42	TL
23.5R25	E-3/L-3	★★	185B 201A2	19.50/2.5	36.0	45	TL
26.5R25	E-3/L-3	★★	193B 209A2	22.00/3.0	37.0	47	TL
29.5R25	E-3/L-3	★★	200B 216A2	25.00/3.5	43.0	54	TL

\* Multiple Star Rating



## CB386

Loader / Grader

- Light duty classical lug E3/L3 designed for multi application
- Strong sidewall are shaped to minimize the damage from cutting
- Special cut and chip resistance compound

Size	TRA Code	Ply Rating	Service Index	Standard Rim	Tread Depth (mm)	Tread Depth (32nd)	TT/TL
17.5R25	E-3/L-3	★★	167B 182A2	14.00/1.5	27.0	34	TL
20.5R25	E-3/L-3	★★	177B 193A2	17.00/2.0	31.0	39	TL
23.5R25	E-3/L-3	★★	185B 201A2	19.50/2.5	34.0	43	TL
26.5R25	E-3/L-3	★★	193B 219A2	22.00/3.0	37.0	47	TL

\* Multiple Star Rating



# OFF-THE-ROAD TYRES-RADIAL

## CB792

Loader / Earthmover / Grader

- Latest design with alternating and multi-edged blocks offers better flotation and excellent traction on soft and muddy soil
- Longer tread life due to the deeper tread depth and unique tread compound
- Additional protective sidewalls are shaped to minimize damage from cutting
- Optimised Retreading Ability because of the robust casing

Size	TRA Code	Ply Rating	Service Index	Standard Rim	Tread Depth (mm)	Tread Depth (32nd)	TT/TL
23.5R25	E-3+/L-3+	★★	185B 201A2	19.50/2.5	38.0	48	TL
26.5R25	E-3+/L-3+	★★	193B 209A2	22.00/3.0	40.0	50	TL
29.5R25	E-3+/L-3+	★★	200B 216A2	25.00/3.5	44.0	55	TL
650/65R25	E-3/L-3	★★	180B 200A2	19.50/2.5	42.0	53	TL

\* Multiple Star Rating



# OFF-THE-ROAD TYRES-RADIAL

## CB798

Loader / Earthmover / Grader

- Unique winter compound ensure excellent traction in mud and on snow and ice
- New designed sidewall with a protective band on the shoulder/sidewall interface provides good protection against accidental damage
- Open tread pattern in shoulder ensure good self cleaning in the snow and mud

Size	TRA Code	Ply Rating	Service Index	Standard Rim	Tread Depth (mm)	Tread Depth (32nd)	TT/TL
405/70R20			143B 155A2	13.00	19.0	24	TL
14.00R24	G-2	★	153A8	8.00TG	24.0	30	TL
15.5R25	E-3/L-3	★★	160B 176A2	12.00/1.3	25.0	31	TL
17.5R25	E-3/L-3	★★	167B 182A2	14.00/1.5	28.0	35	TL
20.5R25	E-3/L-3	★★	177B 193A2	17.00/2.0	31.0	39	TL
23.5R25	E-3/L-3	★★	185B 201A2	19.50/2.5	34.0	43	TL
650/65R25	E-3/L-3	★★	180B 200A2	19.50/2.5	38.0	48	TL
750/65R25	E-3/L-3	★★	190B 209A2	24.00/3.0	53.0	67	TL





## CB796

### Compact Loader

- Aggressive non-directional tread pattern provides superior traction in soft and mud condition
- Reinforced sidewall protection rib help prevent all kinds of accident damage or hit
- New compound helps reduce heat build up in high speed working

Size	TRA Code	Ply Rating	Service Index	Standard Rim	Tread Depth (mm)	Tread Depth (32nd)	TT/TL
365/70R18	-	-	146A2 135B	11.00	18.0	23	TL
405/70R18	-	-	153A2 141B	13.00	19.0	24	TL
405/70R20	-	-		13.00	19.0	24	TL



## CB387

### Loader / Earthmover / Grader

- The non-directional tread design and open shoulder grooves offer high traction in all application
- Super wide tread width guarantee untra longer tyre life
- Cut resistant tread design for even Wear

Size	TRA Code	Ply Rating	Service Index	Standard Rim	Tread Depth (mm)	Tread Depth (32nd)	TT/TL
23.5R25	E-4/L-4	★★	185B 201A2	19.50/2.5	53.0	67	TL
775/65R29	E-4/L-4	★★	195B 213B	24.00/3.5	56.0	71	TL



# OFF-THE-ROAD TYRES-RADIAL

# OFF-THE-ROAD TYRES-RADIAL



## CB388

Loader / Earthmover / Grader

- ▮ The non-directional E-3 tire for articulated dump truck
- ▮ Cut resistant tread design for even Wear
- ▮ Built-up sidewall for protection against sidewall penetrations

Size	TRA Code	Ply Rating	Service Index	Standard Rim	Tread Depth (mm)	Tread Depth (32nd)	TT/TL
800/80R29	E-3	★★	209B	27.00/3.5	50.0	63	TL



## CB763

Loader / Earthmover / Grader

- ▮ Latest design with alternating and multi-edged blocks offers better flotation and super traction on soft and muddy soil
- ▮ Longer tread life due to the deeper E4/L4 tread depth and unique tread compound
- ▮ Additional protective sidewalls are shaped to minimize damage from cutting
- ▮ Optimised Retreading Ability because of the robust casing

Size	TRA Code	Ply Rating	Service Index	Standard Rim	Tread Depth (mm)	Tread Depth (32nd)	TT/TL
20.5R25	E-4/L-4	★★	177B 193A2	17.00/2.0	50.0	63	TL
23.5R25	E-4/L-4	★★	185B 201A2	19.50/2.5	53.0	67	TL
750/65R25	E-4/L-4	★★	190B 209A2	24.00/3.0	53.0	67	TL
26.5R25	E-4/L-4	★★	193B 209A2	22.00/3.0	56.0	71	TL
29.5R25	E-4/L-4	★★	200B 216A2	25.00/3.5	59.0	74	TL
875/65R29	E-4/L-4	★★	203B 221A2	28.00/3.5	59.0	74	TL

\* Multiple Star Rating



# OFF-THE-ROAD TYRES-RADIAL



## CB773

Loader / Earthmover / Grader

- Super deep tread pattern designed for wheel loader, dozer and grader requiring maximum traction
- Perfect lug face ensures equal load distribution and even contact area
- Additional protective sidewalls are shaped to minimize damage from cutting
- Optimised Retreading Ability because of the robust casing

Size	TRA Code	Ply Rating	Service Index	Standard Rim	Tread Depth (mm)	Tread Depth (32nd)	TT/TL
20.5R25	L-5	★★	193A2	17.00/2.0	70.0	88	TL
23.5R25	L-5	★★	201A2	19.50/2.5	76.0	96	TL
26.5R25	L-5	★★	209A2	22.00/3.0	86.0	108	TL
29.5R25	L-5	★★	216A2	25.00/3.5	94.0	118	TL



# OFF-THE-ROAD TYRES-RADIAL



## CB790

Loader / Earthmover / Grader

- Super deep open tread pattern designed for wheel loader, dozer and grader requiring maximum traction
- Substantial crown and robust shoulders reinforced with a protection band make up a tyre
- Additional protective sidewalls are shaped to minimize damage from cutting
- Optimised Retreading Ability because of the robust casing

Size	TRA Code	Ply Rating	Service Index	Standard Rim	Tread Depth (mm)	Tread Depth (32nd)	TT/TL
15.5R25	L-5	★★	176A2	12.00/1.3	60.0	76	TL
17.5R25	L-5	★★	182A2	14.00/1.5	68.0	86	TL
20.5R25	L-5	★★	193A2	17.00/2.0	72.0	91	TL
23.5R25	L-5	★★	201A2	19.50/2.5	78.0	98	TL
26.5R25	L-5	★★	209A2	22.00/3.0	88.0	111	TL
29.5R25	L-5	★★	216A2	25.00/3.5	96.0	121	TL
35/65R33	L-5	★★	224A2	28.00/3.5	95.0	120	TL





# CB776

Loader / Earthmover / Grader

- Unique non-directional pattern design contributes to efficient fuel consumption and guarantees operating comfort
- Great traction and flotation on soft and muddy surfaces

Size	TRA Code	Ply Rating	Service Index	Standard Rim	Tread Depth (mm)	Tread Depth (32nd)	TT/TL
13.00R24	G-2/L-2	★	146A8	8.00TG	25.0	31	TL
14.00R24	G-2	★	153A8	8.00TG	26.0	33	TL
16.00R24	G-2/L-2	★	161A8	10.00VA	29.0	37	TL



# CB388

Scraper

- The non-directional E-3 tire for high powered scrapers in soft or muddy surfaces
- Cut resistant tread design for even
- WearBuilt-up sidewall for protection against sidewall penetrations

Size	TRA Code	Ply Rating	Service Index	Standard Rim	Tread Depth (mm)	Tread Depth (32nd)	TT/TL
33.25R29	E-3	★★	209B	27.00/3.5	50.0	63	TL





## OFF-THE-ROAD TYRES-RADIAL

# CM770

### Cranes

- Unique irregular wear pattern guarantees greater operator comfort, and lower rolling resistance performance
- Special crane compound help offer shorter braking distance and longer tyre life
- DOT/ECE Certificated



Size	Ply Rating	Service Index	Standard Rim	Tread Depth (mm)	Tread Depth (32nd)	TT/TL
395/85R20(14.00R20)	20PR	170F	10.00	17.5	22	TL
385/95R24(14.00R24)	★★★	170F/170E	10.00/1.5	24.0	30	TT
385/95R25(14.00R25)	★★★	170F/170E	10.00/1.5	24.0	30	TL
445/95R25(16.00R25)	★★★	174F/177E	11.25/2.0	28.0	35	TL
505/95R25(18.00R25)	★★★	186F	13.00/2.5	26.0	33	TL



## OFF-THE-ROAD TYRES-RADIAL Cranes

The cranes has very high speed and heavy load in both highway and rough terrain, which requests a robust but light tyre. ZC Rubber Group cranes tyres is one of the few brands has both the ECE and DOT certificate for all highway crane tyre





# CM399

## Cranes

- Long-lasting non-directional pattern design contributes to efficient fuel consumption and guarantees operating comfort
- Special crane compound help offer shorter braking distance and longer tyre life
- DOT/ECE Certificated

Size	TRA Code	Ply Rating	Service Index	Standard Rim	Tread Depth (mm)	Tread Depth (32nd)	TT/TL
445/95R25(16.00R25)	E-2	★★★	177F	11.25/2.0	26.0	33	TL



# CM767

## Cranes

- Long-lasting non-directional pattern design contributes to efficient fuel consumption and guarantees operating comfort
- Special crane compound help offer shorter braking distance and longer tyre life
- DOT/ECE Certificated

Size	TRA Code	Ply Rating	Service Index	Standard Rim	Tread Depth (mm)	Tread Depth (32nd)	TT/TL
525/80R25(20.5R25)	E-2	★★★	176F/179E	17.00/2.0	28.5	36	TL







# OFF-THE-ROAD TYRES-RADIAL Straddle/Terminal Tractor

More than 8 years experience in more than 65 ports gives me very deep understanding of how port works, what they need, what is the tread in port straddle



## OFF-THE-ROAD TYRES-RADIAL



### CR795

#### Straddle

- Robust rib patterns help to increase dynamic stability and driving comfort during traveling
- Extended longer tyre life due to the sophisticated tread design.
- OEM Certificated

Size	TRA Code	Ply Rating	Service Index	Standard Rim	Tread Depth (mm)	Tread Depth (32nd)	TT/TL
16.00R25	STRADDLE	★★	202A7	11.25/2.0	48.0	60	TL
480/95R25	STRADDLE	★★	206A5	13.00/2.5	50.0	63	TL



# OFF-THE-ROAD TYRES-RADIAL

# OFF-THE-ROAD TYRES-RADIAL



## CR390

### Straddle

- Revolutionary new pattern design with extra steel belt casing help increase the stability
- Better footprint guarantee even wear in the tread
- High intensive under tread rubber prevent the crack in tyre tread lug

Size	TRA Code	Ply Rating	Service Index	Standard Rim	Tread Depth (mm)	Tread Depth (32nd)	TT/TL
16.00R25	STRADDLE	★★	202A7	11.25/2.0	51	64	TL



## CR380

### Terminal Tractor

- Strong and wide rib help offer outstanding stability and excellent traction
- Special designed for terminal tractors
- Static free compound

Size	TRA Code	Ply Rating	Service Index	Standard Rim	Tread Depth (mm)	Tread Depth (32nd)	TT/TL
280/75R22.5	—	—	168A8	8.25	32.0	40	TL
310/80R22.5	—	—	175A8	9.00	32.0	40	TL



## OFF-THE-ROAD TYRES-RADIAL



# CB382

## Heavy Forklift

- ▶ New generation radial heavy forklift tyres.
- ▶ Both available in TT and TL
- ▶ Robust sidewall guarantee great low deflection rate
- ▶ Cool running compound offer low heat build up in operation

Size	TRA Code	Ply Rating	Service Index	Standard Rim	Tread Depth (mm)	Tread Depth (32nd)	TT/TL
10.00R20	—	—	166A5	7.50	35.0	44	TT/TL
12.00R20	—	—	176A5	8.50	40.0	50	TT/TL
12.00R24	—	—	178A5	8.50	40.0	50	TT/TL
14.00R24	—	—	193A5	10.00/2.0	64.0	81	TT/TL



## OFF-THE-ROAD TYRES-RADIAL Rigid Dump Truck

The rigid dump trucks are primarily used in mines and large construction sites. Safety, Zero Harm, High Efficiency and Low Hour Cost is always the mines operation's priority concern. ZC Rubber developed a full range of rigid dump truck tyres up to 100 tones, Powerful Japanese RD teams designed massive tyre compounds for different applications, no matter in cold and hot, coal and iron ore, you can find the suitable ZC products for your machine



# CB765

## Rigid Dump Truck

- Rock flush pattern provide excellent defense again impacts and cuts
- Unique compounds generate longer tyre life and fewer punctures
- Four steel belts offer greater strength and durability
- Optimised Retreading Ability because of the robust casing

Size	TRA Code	Ply Rating	Service Index	Standard Rim	Tread Depth (mm)	Tread Depth (32nd)	TT/TL
13.00R25	E-3	★★★	163B	10.00	27.0	34	TT
14.00R25	E-3	★★★	169B	10.00	27.0	34	TT
24.00R35	E-4	★★	209B	17.00/3.5	57.0	72	TL



# CB793

## Rigid Dump Truck

- Innovative Lug Pattern helps provide excellent traction on gravel, packed earth and mud
- Unique compound provides long tread life by generating low heat
- Non directional design provides even wear and long tread life

Size	TRA Code	Ply Rating	Service Index	Standard Rim	Tread Depth (mm)	Tread Depth (32nd)	TT/TL
14.00R24	E-3	★★★	169B	10.00/1.5	31.00	39	TT
13.00R25	E-3	★★★	163B	10.00/1.5	29.00	37	TT
14.00R25	E-3	★★★	169B	10.00/1.5	31.00	39	TT

# CB793A

Size	TRA Code	Ply Rating	Service Index	Standard Rim	Tread Depth (mm)	Tread Depth (32nd)	TT/TL
14.00R25	E-3	★★★	169B	10.00/1.5	27.00	34	TT

Note: Please consult your sales representative for CB793A





# CB771

## Rigid Dump Truck

- Aggressive lug design with large blocks at tread centre provides excellent traction and braking on rough road
- Different compounds to optimize performance in all applications
- Additional protective sidewalls are shaped to minimize damage from cutting
- Optimised Retreading Ability because of the robust casing

Size	TRA Code	Ply Rating	Service Index	Standard Rim	Tread Depth (mm)	Tread Depth (32nd)	TT/TL
14.00R25	E-4	★★★★	169B	10.00	38.0	48	TT/TL
16.00R25	E-4	★★	177B	11.25/2.0	44.0	55	TT/TL
18.00R25	E-4	★★★★	189B	13.00/2.5	51.0	64	TL
18.00R33	E-4	★★★★	211B	13.00/2.5	54.0	68	TL
21.00R33	E-4	★★★★	203B	15.00/3.0	54.0	68	TL
21.00R35	E-4	★★★★	204B	15.00/3.0	61.0	77	TL
24.00R35	E-4	★★★★	212B	17.00/3.5	65.0	82	TL

# CB771A

Size	TRA Code	Ply Rating	Service Index	Standard Rim	Tread Depth (mm)	Tread Depth (32nd)	TT/TL
14.00R25	E-4	★★★★	169B	10.00/1.5	38.0	48	TT

Note: Please consult your sales representative for CB771A



# CB393

## Rigid Dump Truck

- Aggressive lug design with large blocks at tread centre provides excellent traction and braking on rough road
- Different compounds to optimize performance in all applications
- Additional protective sidewalls are shaped to minimize damage from cutting
- Optimised Retreading Ability because of the robust casing

Size	TRA Code	Ply Rating	Service Index	Standard Rim	Tread Depth (mm)	Tread Depth (32nd)	TT/TL
13.00R25	E-3	★★★★	163B/182A2	10.00/1.5	27.0	34	TT/TL
14.00R25	E-3	★★★★	169B/188A2	10.00/1.5	27.0	34	TT/TL





# CB395

## Rigid Dump Truck

- Aggressive lug design with large blocks at tread centre provides excellent traction and braking on rough road
- Different compounds to optimize performance in all applications
- Additional protective sidewalls are shaped to minimize damage from cutting
- Optimised Retreading Ability because of the robust casing

Size	TRA Code	Ply Rating	Service Index	Standard Rim	Tread Depth (mm)	Tread Depth (32nd)	TT/TL
14.00R25	E-3	★★★	169B/188A2	10.00/1.5	27.0	34	TT/TL
16.00R25	E-3	★★	177B	11.25/2.0	34.0	43	TT/TL



# CB397

## Rigid Dump Truck

- Aggressive lug design with large blocks at tread centre provides excellent traction and braking on rough road
- Different compounds to optimize performance in all applications
- Additional protective sidewalls are shaped to minimize damage from cutting
- Optimised Retreading Ability because of the robust casing

Size	TRA Code	Ply Rating	Service Index	Standard Rim	Tread Depth (mm)	Tread Depth (32nd)	TT/TL
13.00R25	E-3	★★★	163B/182A2	10.00/1.5	27.0	34	TT/TL
14.00R25	E-3	★★★	169B/188A2	10.00/1.5	27.0	34	TT/TL
16.00R25	E-3	★★	177B	11.25/2.0	34.0	43	TT/TL





# CB761

## Rigid Dump Truck

- ▶ A revolutionary design with independent tread pattern blocks guarantee excellent traction and longer tyre life in tough road application
- ▶ Different compounds to optimize performance in all applications
- ▶ Additional protective sidewalls are shaped to minimize damage from cutting
- ▶ Optimised Retreading Ability because of the robust casing

Size	TRA Code	Ply Rating	Service Index	Standard Rim	Tread Depth (mm)	Tread Depth (32nd)	TT/TL
21.00R35	E-3	★★	201B	15.00/3.0	44.0	55	TL



# CB791

## Rigid Dump Truck

- ▶ Aggressive lug design with extra deep grooves offer strong traction for dump trucks requiring power traction to travel over soft and muddy terrain
- ▶ Different compounds to optimize performance in all applications
- ▶ Additional protective sidewalls are shaped to minimize damage from cutting
- ▶ Optimised Retreading Ability because of the robust casing

Size	TRA Code	Ply Rating	Service Index	Standard Rim	Tread Depth (mm)	Tread Depth (32nd)	TT/TL
27.00R49	E-4	★★	223B	19.50/4.0	72.0	91	TL



## OFF-THE-ROAD TYRES-RADIAL



# CB999

## Rigid Dump Truck

- ▶ Rugged tread blocks and tread design offer outstanding off-road traction
- ▶ Tough tread rubber compounds help resist chipping and chunking
- ▶ Enhanced traction in mud and sand

Size	TRA Code	Ply Rating	Service Index	Standard Rim	Tread Depth (mm)	Tread Depth (32nd)	TT/TL
16.00R20	E-7	28PR	174/171G	10.00W	20.0	25	TT/TL



## OFF-THE-ROAD TYRES-RADIAL Underground Mining Tyre

Vehicles are faced with the most extreme working conditions in underground mines. To stand up to fallen rock debris, flooding and heat encountered in the extraction of minerals, tyres must be 100% reliable in the most testing conditions. ZC Rubber developed a full range of underground mining tyres, which is capable of greater resistance to these various stresses and strains and carrying even more load.



# OFF-THE-ROAD TYRES-RADIAL

## CB797

Loader / Dozer / Grader/ Scraper

- Smooth extra deep tread tyres designed for all kinds of operations on severe rocky surface
- Enforced sidewall protection rib help reduce all kinds of damage to sidewall
- ZC rubber unique cut resistance compound ensures a maximum resistance to cut & wearing

Size	TRA Code	Ply Rating	Service Index	Standard Rim	Tread Depth (mm)	Tread Depth (32nd)	TT/TL
10.00R20	L-5S	-	166A2	7.50	36.5	46	TL
12.00R20	L-5S	-	176A2	8.50	48.0	60	TL
17.5R25	L-5S	★★	182A2	14.00/1.5	66.0	83	TL
26.5R25	L-5S	★★	209A2	22.00/3.0	94.0	118	TL
18.00R25	L-5S	★★★	206A2	13.00/2.5	82.0	103	TL
29.5R29	L-5S	★★	218A2	25.00/3.5	100.0	126	TL



# OFF-THE-ROAD TYRES-BIAS Loader / Earthmover / Grader



Classic no-directional tread design formulated with Cut resistance compound  
Together with a robust duty nylon carcass makes it capable of withstanding cuts in all tough service conditions

## CL728

Loader / Earthmover / Grader

Size	TRA Code	Ply Rating	Standard Rim	Tread Depth (mm)	Overall Diameter (mm)	Section Width (mm)	Max. Load Capacity (kg)	Cold Inflation Pressure (kPa)	TT/TL
23.5-25	E-3	16	19.50/2.5	33.0	1615	595	6150	225	TT/TL
	L-3	16	19.50/2.5	33.0	1615	595	9500	300	TT/TL
	E-3	20	19.50/2.5	33.0	1615	595	7300	300	TT/TL
	L-3	20	19.50/2.5	33.0	1615	595	10900	375	TT/TL
	E-3	24	19.50/2.5	33.0	1615	595	8000	350	TT/TL
	L-3	24	19.50/2.5	33.0	1615	595	12500	475	TT/TL
29.5-25	E-3	28	25.00/3.5	50.0	1875	750	11500	325	TL
	L-3	28	25.00/3.5	50.0	1875	750	17500	425	TL
	L-3	34	25.00/3.5	50.0	1875	750	20000	525	TL



Classic no-directional tread design formulated with Cut resistance compound  
Together with a robust duty nylon carcass makes it capable of withstanding cuts in all tough service conditions

## E3/L3

Loader / Earthmover / Grader

Size	TRA Code	Ply Rating	Standard Rim	Tread Depth (mm)	Overall Diameter (mm)	Section Width (mm)	Max. Load Capacity (kg)	Cold Inflation Pressure (kPa)	TT/TL
16.00-25	E-3	28	11.25/2.0	29.0	1495	430	6700	575	TT/TL
	L-3	28	11.25/2.0	29.0	1495	430	11500	750	TT/TL
	E-3	32	11.25/2.0	29.0	1495	430	7300	650	TT/TL
	L-3	32	11.25/2.0	29.0	1495	430	16875	1000	TT/TL
26.5-25	E-3	20	22.00/3.0	39.0	1750	675	8250	250	TT/TL
	L-3	20	22.00/3.0	39.0	1750	675	13200	350	TT/TL
	E-3	28	22.00/3.0	39.0	1750	675	10000	350	TT/TL
	L-3	28	22.00/3.0	39.0	1750	675	15500	475	TT/TL



Classic no-directional tread design formulated with Cut resistance compound  
Together with a robust duty nylon carcass makes it capable of withstanding cuts in all tough service conditions

## CL729

Loader / Earthmover / Grader

Size	TRA Code	Ply Rating	Standard Rim	Tread Depth (mm)	Overall Diameter (mm)	Section Width (mm)	Max. Load Capacity (kg)	Cold Inflation Pressure (kPa)	TT/TL
17.5-25	E-3	12	14.00/1.5	26.0	1350	445	3650	225	TT/TL
	L-3	12	14.00/1.5	26.0	1350	445	6150	350	TT/TL
	E-3	16	14.00/1.5	26.0	1350	445	4250	300	TT/TL
	L-3	16	14.00/1.5	26.0	1350	445	7300	470	TT/TL
	E-3	16	17.00/2.0	31.0	1495	520	5450	275	TT/TL
20.5-25	L-3	16	17.00/2.0	31.0	1495	520	8250	350	TT/TL
	E-3	20	17.00/2.0	31.0	1495	520	6000	325	TT/TL
	L-3	20	17.00/2.0	31.0	1495	520	9500	450	TT/TL



Extra deep tread depth offers the tyres much longer life with lower cost per hour  
Cut resistance compound suitable for loader and haulage operation under all tough conditions

## CL629

Loader / Earthmover / Grader

Size	TRA Code	Ply Rating	Standard Rim	Tread Depth (mm)	Overall Diameter (mm)	Section Width (mm)	Max. Load Capacity (kg)	Cold Inflation Pressure (kPa)	TT/TL
26.5-25	E-3+	28	22.00/3.0	42	1750	675	10000	350	TL
	E-3+	32	22.00/3.0	42	1750	675	11200	425	TL
	L-3+	28	22.00/3.0	42	1750	675	15500	475	TL
	L-3+	32	22.00/3.0	42	1750	675	17000	550	TL
	L-3+	36	22.00/3.0	42	1750	675	24200	750	TL



### 23.5-25

Classic no-directional tread design formulated with Cut resistance compound  
Robust casing with unique cut resistance compound provides longer life

### 26.5-25

Extra deep non directional sturdy lug pattern provides good traction for rugged mining, quarrying  
Robust casing with unique cut resistance compound provides longer life

### 35/65-33

Special designed for big loaders with tough working condition  
Unique cut resistance tread compound and tough carcass prevents cuts and impact damage

## EL27

Loader / Earthmover / Grader

Size	TRA Code	Ply Rating	Standard Rim	Tread Depth (mm)	Overall Diameter (mm)	Section Width (mm)	Max. Load Capacity (kg)	Cold Inflation Pressure (kPa)	TT/TL
23.5-25	L-3	20	19.5/2.5	35	1615	595	10900	375	TL
	E-3	20	19.5/2.5	35	1615	595	7300	300	TL
26.5-25	L-4	28	22.00/3.0	54	1780	675	15500	475	TL
	E-4	28	22.00/3.0	54	1780	675	10000	350	TL
35/65-33	L-5	36	28.00/3.5	100	2075	890	23600	525	TL
35/65-33	L-5	48	28.00/3.5	100	2075	890	17500(50km/h) 28800(10km/h)	525(50km/h) 725(10km/h)	TL



Extra deep non directional sturdy lug pattern provides good traction for rugged mining quarrying

Unique cut resistance tread compound and tough carcass prevents cuts and impact damage

## EL29

Loader / Earthmover / Grader

Size	TRA Code	Ply Rating	Standard Rim	Tread Depth (mm)	Overall Diameter (mm)	Section Width (mm)	Max. Load Capacity (kg)	Cold Inflation Pressure (kPa)	TT/TL
29.5-25	E-4	28	25.00/3.5	57	1970	830	11500	325	TL
	L-4	28	25.00/3.5	57	1970	830	17500	425	TL
	E-4	34	25.00/3.5	57	1970	830	13000	400	TL
	L-4	34	25.00/3.5	57	1970	830	20000	525	TL



The non-directional standard depth pattern designed for loader/grader  
Special cut resistant tread compound protects tire from all kinds of cuts  
Best option for low intensity application

Note: 17.5-25 EL36 pattern is the left one, 20.5-25 23.-25 EL36 pattern is the right one

## EL36

Loader / Earthmover / Grader

Size	TRA Code	Ply Rating	Standard Rim	Tread Depth (mm)	Overall Diameter (mm)	Section Width (mm)	Max. Load Capacity (kg)	Cold Inflation Pressure (kPa)	TT/TL
17.5-25	E-3	12	14.00/1.5	23.0	1350	445	3650	225	TT/TL
	L-3	12	14.00/1.5	23.0	1350	445	6150	350	TT/TL
	E-3	16	14.00/1.5	23.0	1350	445	4250	300	TT/TL
	L-3	16	14.00/1.5	23.0	1350	445	7300	470	TT/TL
20.5-25	E-3	16	17.00/2.0	25.0	1495	520	5450	275	TT/TL
	L-3	16	17.00/2.0	25.0	1495	520	8250	350	TT/TL
	E-3	20	17.00/2.0	25.0	1495	520	6000	325	TT/TL
	L-3	20	17.00/2.0	25.0	1495	520	9500	450	TT/TL
23.5-25	E-3	16	19.50/2.5	33.0	1615	595	6150	225	TT/TL
	L-3	16	19.50/2.5	33.0	1615	595	9500	300	TT/TL
	E-3	20	19.50/2.5	33.0	1615	595	7300	300	TT/TL
	L-3	20	19.50/2.5	33.0	1615	595	10900	375	TT/TL



## CB716

Loader / Earthmover / Grader

Size	TRA Code	Ply Rating	Standard Rim	Tread Depth (mm)	Overall Diameter (mm)	Section Width (mm)	Max. Load Capacity (kg)	Cold Inflation Pressure (kPa)	TT/TL
13.00-24	G-2/L-2	12	10.0	24.5	1300	350	5600	450	TT
15.5-25	G-2/L-2	12	12.00/1.3	24.5	1275	395	5600	400	TT
	G-2/L-2	16	12.00/1.3	24.5	1275	395	6750	550	TT
17.5-25	G-2	12	14.00/1.5	26.0	1350	445	3650	225	TT/TL
	L-2	12	14.00/1.5	26.0	1350	445	6150	350	TT/TL
	G-2	16	14.00/1.5	26.0	1350	445	4250	300	TT/TL
	L-2	16	14.00/1.5	26.0	1350	445	7300	475	TT/TL

# OFF-THE-ROAD TYRES-BIAS



## G2/L2

Loader / Earthmover / Grader

Size	TRA Code	Ply Rating	Standard Rim	Tread Depth (mm)	Overall Diameter (mm)	Section Width (mm)	Max. Load Capacity (kg)	Cold Inflation Pressure (kPa)	TT/TL
13.00-24TG	G-2/L-2	12	8.00TG	25.5	1280	335	5600	450	TT/TL
	G-2/L-2	16	8.00TG	25.5	1280	335	6500	600	TT/TL
14.00-24TG	G-2/L-2	12	8.00TG	25.5	1350	360	6300	425	TT/TL
	G-2/L-2	16	8.00TG	25.5	1350	360	7300	550	TT/TL



## E3/L3

Loader / Earthmover / Grader

Size	TRA Code	Ply Rating	Standard Rim	Tread Depth (mm)	Overall Diameter (mm)	Section Width (mm)	Max. Load Capacity (kg)	Cold Inflation Pressure (kPa)	TT/TL
14.00-24	E-3/L-3	16	10.0	25.5	1370	375	7300	550	TT/TL
	E-3/L-3	24	10.0	25.5	1370	375	9500	850	TT/TL
	E-3/L-3	28	10.0	25.5	1370	375	10000	925	TT
15.5-25	E-3/L-3	12	12.00/1.3	24.5	1275	395	5600	400	TT/TL
	E-3/L-3	16	12.00/1.3	24.5	1275	395	6750	550	TT



# OFF-THE-ROAD TYRES-BIAS Underground

# OFF-THE-ROAD TYRES-BIAS



## SM05

Underground

Size	TRA Code	Ply Rating	Standard Rim	Tread Depth (mm)	Overall Diameter (mm)	Section Width (mm)	Max. Load Capacity (kg)	Cold Inflation Pressure (kPa)	TT/TL
10.00-20	L-5S	14	7.5	40.0	1055	278	4695	690	TT
12.00-24	L-5S	20	8.5	50.0	1275	315	6900	825	TT
14.00-24	L-5S	28	10	65.0	1370	375	14100	1000	TT
17.50-25	L-5S	24	14.00/1.5	68	1400	445	8850	650	TL
18.00-25	L-5S	32	13.00/2.5	90.0	1675	500	15000	750	TL
26.5-25	L-5S	36	22.00/3.0	96.0	1800	675	18300	625	TL



## SM03

Underground

Size	TRA Code	Ply Rating	Standard Rim	Tread Depth (mm)	Overall Diameter (mm)	Section Width (mm)	Max. Load Capacity (kg)	Cold Inflation Pressure (kPa)	TT/TL
10.00-20	L-4S	14	7.5	31.0	1055	278	4695	690	TT
12.00-24	L-4S	20	8.5	35.0	1275	315	6900	825	TT



# OFF-THE-ROAD TYRES-BIAS

## Compactor

# OFF-THE-ROAD TYRES-BIAS



## C-7/EC72

Compactor

Size	TRA Code	Ply Rating	Standard Rim	Tread Depth (mm)	Overall Diameter (mm)	Section Width (mm)	Max. Load Capacity (kg)	Cold Inflation Pressure (kPa)	TT/TL
14.9-24	EC72	8	W13	21.0	1241	378	1760	180	TT/TL
18.4-26	EC72	12	DW16	23.0	1400	440	2985	230	TT/TL
23.1-26	C-7	8	DW20	17.0	1500	595	4000	140	TT/TL
	C-7	12	DW20	17.0	1500	595	5150(10km/h)	200	TT/TL



## CS730

Compactor

Size	TRA Code	Ply Rating	Standard Rim	Tread Depth (mm)	Overall Diameter (mm)	Section Width (mm)	Max. Load Capacity (kg)	Cold Inflation Pressure (kPa)	TT/TL
14.00-24	L-4S	20	10.0	45	1360	360	8500	700	TT
	L-4S	24	10.0	45	1360	360	10000	925	TT



## CS726

Compactor

Size	TRA Code	Ply Rating	Standard Rim	Tread Depth (mm)	Overall Diameter (mm)	Section Width (mm)	Max. Load Capacity (kg)	Cold Inflation Pressure (kPa)	TT/TL
9.5/65-15	C-1	7JA	6.0	31.5	675	236	1315	325	TL
10.5/80-16	C-1	8LB	6.0	26	810	274	1875	300	TL
11.00-20	C-1	16	8.0	22.5	1080	290	5430	725	TT
	C-1	24	8.0	22.5	1080	290	7075	1125	TT
13/80-20	C-1	16	8.5	22.0	1060	319	5430	800	TT



# OFF-THE-ROAD TYRES-BIAS Dump Truck



# CL735

Dump Truck

Size	TRA Code	Ply Rating	Standard Rim	Tread Depth (mm)	Overall Diameter (mm)	Section Width (mm)	Max. Load Capacity (kg)	Cold Inflation Pressure (kPa)	TT/TL
10.00-20	E-3	18	7.5	26.0	1073	278	5445	890	TT
11.00-20	E-3	20	8.0	30.0	1105	293	5535	900	TT
12.00-20	E-3	20	8.5	30.0	1145	315	6335	900	TT
12.00-24	E-3+	24	8.5	30	1275	315	7500	975	TT
14.00-24	E-3+	24	10.0	32	1370	375	8400	850	TT
	E-3+	28	10.0	32	1370	375	10000	925	TT
13.00-25	E-3	28	8.5	32	1300	350	9380	1050	TT
	E-3	36	8.5	32	1300	350	10625	1300	TT
14.00-25	E-3+	28	10.00	32	1370	375	10000	925	TT
	E-3+	36	10.00	32	1370	375	11645	1200	TT
18.00-25	E-3	32	13.00/25	38.0	1615	495	8750	575	TT/TL
	L-3	32	13.00/25	38.0	1615	495	15000	750	TT/TL
	E-3	36	13.00/25	38.0	1615	495	9250	625	TT/TL
	L-3	36	13.00/25	38.0	1615	495	16000	850	TT/TL



# CL710

Dump Truck

Size	Ply Rating	Service Index	Standard Rim	Tread Depth (mm)	Overall Diameter (mm)	Section Width (mm)	Max. Load Capacity (kg)	Cold Inflation Pressure (kPa)	TT/TL
11.00-20	20	-	8.0	33.0	1105	293	5535	900	TT
12.00-20	20	-	8.5	33.0	1145	315	6335	900	TT
12.00-24	20	160/156G	8.5	35	1247	315	4500	880	TT



# EL35

Dump Truck

Size	TRA Code	Ply Rating	Standard Rim	Tread Depth (mm)	Overall Diameter (mm)	Section Width (mm)	Max. Load Capacity (kg)	Cold Inflation Pressure (kPa)	TT/TL
16.00-25	E-3	32	11.25/2.0	38	1495	430	7300	650	TT
18.00-25	E-4	32	13.00/2.5	55	1675	500	8750	575	TT/TL
	E-4	36	13.00/2.5	55	1675	500	9250	625	TT/TL
18.00-33	E-4	32	13.00/2.5	52	1875	500	10000	575	TL
21.00-33	E-3	32	15.00/3.0	46	1940	570	10300	500	TL
21.00-35	E-4	36	15.00/3.0	51	2005	570	12850	550	TL
	E-4	40	15.00/3.0	51	2005	570	14000	625	TL
24.00-35	E-4	42	17.00/3.5	55	2175	655	16500	550	TL
	E-4	48	17.00/3.5	55	2175	655	18500(50km/h) 31500(10km/h)	650(50km/h) 850(10km/h)	TL



# CL739

Dump Truck

Size	TRA Code	Ply Rating	Standard Rim	Tread Depth (mm)	Overall Diameter (mm)	Section Width (mm)	Max. Load Capacity (kg)	Cold Inflation Pressure (kPa)	TT/TL
11.00-20	E-3	20	8.0	27.0	1105	293	5535	900	TT
12.00-20	E-3	20	8.5	27.0	1145	315	6335	900	TT
12.00-24	E-3	24	8.5	26	1275	315	7500	975	TT



# CL969

Dump Truck

Size	LR/PR	Standard Rim	Tread Depth (mm)	Overall Diameter (mm)	Section Width (mm)	Max. Load (kg)		Cold Inflation (kPa)		TT/TL
						Single	Dual	Single	Dual	
12.00-20	J/18	8.5	23.0	1125	315	3750	3350	810	740	TT
	L/20	8.5	23.0	1125	315	4000	3450	880	810	TT
12.00-24	J/18	8.5	23.0	1225	315	4250	3750	810	740	TT
	L/20	8.5	23.0	1225	315	4500	4000	880	810	TT



# CL736

Dump Truck

Size	TRA Code	Ply Rating	Standard Rim	Tread Depth (mm)	Overall Diameter (mm)	Section Width (mm)	Max. Load Capacity (kg)	Cold Inflation Pressure (kPa)	TT/TL
11.00-20	E-3	20	8.0	27	1105	293	5535	900	TT
12.00-20	E-3	20	8.5	27	1145	315	6335	900	TT
14.00-20	E-3	24	10.0	23	1265	375	8400	850	TT
14.00-24	E-3	24	10.0	26	1370	375	8400	850	TT
	E-3	28	10.0	26	1370	375	10000	925	TT
13.00-25	E-3	28	8.5	26	1300	350	9380	1050	TT
	E-3	36	8.5	26	1300	350	10625	1300	TT
14.00-25	E-3	28	10.0	26	1370	375	10000	925	TT
	E-3	36	10.0	26	1370	375	11645	1200	TT



# CL711

Dump Truck

Size	Ply Rating	Service Index	Standard Rim	Tread Depth (mm)	Overall Diameter (mm)	Section Width (mm)	Max. Load Capacity (kg)	Cold Inflation Pressure (kPa)	TT/TL
12.00-24	20	160/156G	8.5	35	1247	315	4500	880	TT



# L9066

Dump Truck

Size	Ply Rating	Service Index	Standard Rim	Tread Depth (mm)	Overall Diameter (mm)	Section Width (mm)	Max. Load Capacity (kg)	Cold Inflation Pressure (kPa)	TT/TL
12.00-24	20+	160/156G	8.5	30	1247	315	4500	880	TT





## OFF-THE-ROAD TYRES-BIAS

## OFF-THE-ROAD TYRES-BIAS Desert Application



### ES01

Desert Application

Size	Ply Rating	Standard Rim	Tread Depth (mm)	Overall Diameter (mm)	Section Width (mm)	10km/h		50km/h	
						Max. Load Capacity (kg)	Cold Inflation Pressure (kPa)	Max. Load Capacity (kg)	Cold Inflation Pressure (kPa)
29.5-25	28	25.00/3.5	22.5	1830	750	-	-	10000	240



### ES02

Desert Application

Size	Ply Rating	Service Index	Standard Rim	Tread Depth (mm)	Overall Diameter (mm)	Section Width (mm)	Max. Load Capacity (kg)	Cold Inflation Pressure (kPa)
9.00-16	8	120N	7JJ	9.5	890	255	1400	310
9.00-17	8	121N	7 1/2J	9.5	910	255	1450	310



## OFF-THE-ROAD TYRES-BIAS

## OFF-THE-ROAD TYRES-BIAS Backhoe



### EL23

Backhoe

Size	TRA Code	Ply Rating	Standard Rim	Tread Depth (mm)	Overall Diameter (mm)	Section Width (mm)	Max. Load Capacity (kg)	Cold Inflation Pressure (kPa)	T/TL
14.9-24	R-4	12	W13	26	1241	378	2900	290	TL
18.4-24	R-4	12	W16L	29	1375	467	3875	250	TL
19.5L-24	R-4	12	DW16A	27	1314	485	3450	230	TL
	R-4	14	DW16A	27	1314	485	3750	260	TL
18.4-26	R-4	12	DW16	30	1425	467	4000	250	TL
16.9-28	R-4	12	W15L	31	1410	430	3550	260	TL
18.4-28	R-4	12	W16L	29	1476	467	3135	220	TL
16.9-30	R-4	12	W15L	29	1427	405	3878	300	TL



### EL53

Backhoe

Size	TRA Code	Ply Rating	Standard Rim	Tread Depth (mm)	Overall Diameter (mm)	Section Width (mm)	Max. Load Capacity (kg)	Cold Inflation Pressure (kPa)	T/TL
10.5/80-18	R-4	10	9	26	905	274	1935	370	TL
10.5/80-18	R-4	12	9	26	905	274	1350	370	TL
12.5/80-18	R-4	12	9	26	985	308	2625	370	TL
	R-4	14	9	26	985	308	2910	430	TL
16.9-24	R-4	12	W15L	34	1310	429	3250	260	TL



# CB526

Backhoe

Size	TRA Code	Ply Rating	Standard Rim	Tread Depth (mm)	Overall Diameter (mm)	Section Width (mm)	Max. Load Capacity (kg)	Cold Inflation Pressure (kPa)	TT/TL
19.5L-24	R-4	12	DW16	27	1340	495	2145	210	TT



# R-4

Backhoe

Size	TRA Code	Ply Rating	Standard Rim	Tread Depth (mm)	Overall Diameter (mm)	Section Width (mm)	Max. Load Capacity (kg)	Cold Inflation Pressure (kPa)	TT/TL
17.5L-24	R-4	12	W15L	25.5	1241	434	2995	250	TL
19.5L-24	R-4	12	DW16A	27.0	1314	485	3450	230	TL
	R-4	14	DW16A	27.0	1314	485	3750	260	TL
21L-24	R-4	12	DW18A	27.5	1378	533	3875	220	TL



# EL28

Backhoe

Size	TRA Code	Ply Rating	Standard Rim	Tread Depth (mm)	Overall Diameter (mm)	Section Width (mm)	Max. Load Capacity (kg)	Cold Inflation Pressure (kPa)	TT/TL
16/70-16	L-2	12	10.00F	17.5	940	380	1990	325	TT
20.5/70-16	L-2	14	13SDC	17.2	1070	480	2290	325	TT
7.50-16	L-2	12	6.00G	14	805	215	1030	375	TT
8.25-16	L-2	14	6.50H	13	855	235	1240	425	TT
9.00-16	L-2	14	6.50H	14	890	255	1340	425	TT
11.00-16	L-2	14	7.00N	15	980	285	1655	375	TT
12.00-16	L-2	14	7.00N	15.5	1020	300	1810	375	TT



# CB715

Backhoe

Size	TRA Code	Ply Rating	Standard Rim	Tread Depth (mm)	Overall Diameter (mm)	Section Width (mm)	Load Capacity at various speed (kg)		TT/TL
							10km/h	50km/h	
16/70-20	E-3/L-3	14	13SDC	22.5	1075	410	5100(450kPa)	2900(350kPa)	TT
16/70-24	E-3/L-3	14	13SDC	22.5	1175	410	5600(450kPa)	3350(350kPa)	TT

# OFF-THE-ROAD TYRES-BIAS



## EL56

Backhoe

Size	TRA Code	Ply Rating	Standard Rim	Tread Depth (mm)	Overall Diameter (mm)	Section Width (mm)	Max. Load Capacity (kg)	Cold Inflation Pressure (kPa)	TT/TL
16/70-20	E-3/L-3	14	13SDC	18	1175	410	5150	450	TT
16/70-20	E-3/L-3	16	13SDC	18	1175	410	5485	500	TT
16/70-20	E-3/L-3	18	13SDC	18	1175	410	5800	550	TT
16/70-24	E-3/L-3	16	13SDC	18	1175	410	5955	500	TT



## EL55

Backhoe

Size	Ply Rating	Standard Rim	Tread Depth (mm)	Overall Diameter (mm)	Section Width (mm)	Load Capacity at various speed (kg)				Cold Inflation Pressure (kPa)	TT/TL
						10km/h	25km/h	40km/h	50km/h		
9.00-20	14	7	20.0	1038	259	4385	3230	2885	2770	760	TT



## EL36

Backhoe

Size	TRA Code	Ply Rating	Standard Rim	Tread Depth (mm)	Overall Diameter (mm)	Section Width (mm)	Max. Load Capacity (kg)	Cold Inflation Pressure (kPa)	TT/TL
11.00-16	L-2	14	7.00N	15.0	900	265	1715	375	TT
12.00-16	L-2	14	7.00N	15.5	920	280	2105	375	TT
16/70-16	L-2	14	10.00F	17.0	895	340	2400	375	TT
20.5/70-16	L-2	14	7.00N	17.5	930	360	2700	375	TT



# OFF-THE-ROAD TYRES-BIAS Special Machines

# OFF-THE-ROAD TYRES-BIAS



## M9088

Special Machines/Logger

Size	LR/PR	Standard Rim	Tread Depth (mm)	Overall Diameter (mm)	Section Width (mm)	Max. Load (kg)		Cold Inflation (kPa)		TT/TL
						Single	Dual	Single	Dual	
10.00-20	J/18	7.0	21.6	1073	278	3350	2900	910	840	TT
11.00-20	J/18	8.0	22.0	1105	293	3650	3150	910	840	TT
12.00-20	L/20	8.5	22.0	1125	315	4000	3450	880	810	TT
14.00-20	L/20	10.0	21.0	1240	375	5000	4375	770	700	TT



## ELO8

Special Machines/Logger

Size	Ply Rating	Standard Rim	Tread Depth (mm)	Section Width (mm)	Load Capacity at various speed (kg)				Cold Inflation Pressure (kPa)	TT/TL
					10km/h	25km/h	40km/h	50km/h		
8.25-20	14	6.5	18	235	3865	2845	2540	2440	830	TT
9.00-20	14	7.0	19	259	4385	3230	2885	2440	760	TT
10.00-20	16	7.5	20	278	5090	3750	3350	3215	790	TT
11.00-20	16	8.0	21	293	5405	3985	3555	3415	760	TT

Unique CRC compound offers excellent protection against accidental damage to tread and sidewall  
 Special designed sidewall protect rib increase the cut-resistance and vehicle stability  
 Deeper tread depth guarantee longer tyre life



# OFF-THE-ROAD TYRES-BIAS Logger

# OFF-THE-ROAD TYRES-BIAS



Tubeless design for touch logging application  
 Higher ply to meet the heavier load and higher-power machines  
 Unique cut resistance compound for off road application

## LS25

Special Machines/Logger

Size	TRA Code	Ply Rating	Standard Rim	Tread Depth (mm)	Overall Diameter (mm)	Section Width (mm)	Max. Load Capacity (kg)	Cold Inflation Pressure (kPa)	TI/TL
23.1-26	LS-2	16	DW20A	55	1560	587	4450	240	TL
30.5L-32	LS-2	26	DW27	55	1847	775	7100	280	TL



# OFF-THE-ROAD TYRES-BIAS Skid Steer



# EL77

Skid Steer

Size	TRA Code	Ply Rating	Standard Rim	Tread Depth (mm)	Overall Diameter (mm)	Section Width (mm)	Max. Load Capacity (kg)	Cold Inflation Pressure (kPa)	TI/TL
10-16.5	L-5	10	8.25	31	773	264	2135	520	TL
	L-5	12	8.25	40	773	264	2375	620	TL
12-16.5	L-5	12	9.75	35	831	307	2865	550	TL
	L-5	14	9.75	40	831	307	3075	620	TL



# CL718

Skid Steer

Size	TRA Code	Ply Rating	Standard Rim	Tread Depth (mm)	Overall Diameter (mm)	Section Width (mm)	Max. Load Capacity (kg)	Cold Inflation Pressure (kPa)	TI/TL
10-16.5	-	8	8.25	15.0	773	264	1880	410	TL
12-16.5	-	10	9.75	18.0	831	307	2540	450	TL



# CL719

Skid Steer

Size	TRA Code	Ply Rating	Standard Rim	Tread Depth (mm)	Overall Diameter (mm)	Section Width (mm)	Max. Load Capacity (kg)	Cold Inflation Pressure (kPa)	TI/TL
10-16.5	-	8	8.25	15.0	773	264	1880	410	TL
	-	10	8.25	15.0	773	264	2135	520	TL
12-16.5	-	10	9.75	18.0	831	307	2540	450	TL
	-	12	9.75	18.0	831	307	2865	550	TL



# CL720

Skid Steer

Size	TRA Code	Ply Rating	Standard Rim	Tread Depth (mm)	Overall Diameter (mm)	Section Width (mm)	Max. Load Capacity (kg)	Cold Inflation Pressure (kPa)	TI/TL
10-16.5	-	12	8.25	25.0	773	264	2375	620	TL



# CL721

Skid Steer

Size	TRA Code	Ply Rating	Standard Rim	Tread Depth (mm)	Overall Diameter (mm)	Section Width (mm)	Max. Load Capacity (kg)	Cold Inflation Pressure (kPa)	TI/TL
12-16.5	-	14	9.75	35.0	931	307	3075	620	TL

# OFF-THE-ROAD TYRES-BIAS



## CL723

Skid Steer

Size	TRA Code	Ply Rating	Standard Rim	Tread Depth (mm)	Overall Diameter (mm)	Section Width (mm)	Max. Load Capacity (kg)	Cold Inflation Pressure (kPa)	TI/TL
10-16.5	-	10	8.25	22.0	773	264	2135	520	TL
12-16.5	-	12	9.75	24.0	831	307	2865	550	TL
14-17.5	-	14	10.50	22.0	921	349	3875	550	TL



## K192

Skid Steer

Size	TRA Code	Ply Rating	Standard Rim	Tread Depth (mm)	Overall Diameter (mm)	Section Width (mm)	Max. Load Capacity (kg)	Cold Inflation Pressure (kPa)	TI/TL
10-16.5	-	8	8.25	19.5	773	264	1880	410	TL
10-16.5	-	10	8.25	19.5	773	264	2135	520	TL
12-16.5	-	10	9.75	22.0	831	307	2540	450	TL



# OFF-THE-ROAD TYRES-BIAS Port Service





# CL629

Port Service

Size	TRA Code	Ply Rating	Standard Rim	Tread Depth (mm)	Overall Diameter (mm)	Section Width (mm)	Load Capacity at various speed (kg)				Cold Inflation Pressure (kPa)	TT/TL
							0km/h	5km/h	10km/h	25km/h		
12.00-24	IND-4	24	8.5	35.0	1245	315	12420	10005	9315	8625	1000	TT
	IND-4	24	10.0	50.0	1370	375	17000	13800	12800	11500	1000	TT/TL
14.00-24	IND-4	28	10.0	50.0	1370	375	18000	14500	13500	12000	1000	TT/TL
	IND-4	32	10.0	50.0	1370	375	18450	14850	13850	12800	1000	TT/TL
16.00-25	IND-4	32	11.25/2.0	50.0	1495	430	22500	18100	16900	15600	1050	TT/TL
	IND-4	36	11.25/2.0	50.0	1495	430	24500	19700	18400	17000	1170	TT/TL
18.00-25	IND-4	40	13.00/2.5	55.0	1675	515	31500	25400	23600	21900	1000	TT/TL
18.00-33	IND-4	40	13.00/2.5	70.0	1875	500	38200	30700	28600	26500	1000	TL



# CL629A

Port Service

Size	TRA Code	Ply Rating	Standard Rim	Tread Depth (mm)	Overall Diameter (mm)	Section Width (mm)	Load Capacity at various speed (kg)				Cold Inflation Pressure (kPa)	TT/TL
							0km/h	5km/h	10km/h	25km/h		
12.00-24	IND-4	24	8.5	40	1245	315	12300	10800	9300	7100	1000	TT



# CL629K

Port Service

Size	TRA Code	Ply Rating	Standard Rim	Tread Depth (mm)	Overall Diameter (mm)	Section Width (mm)	Load Capacity at various speed (kg)				Cold Inflation Pressure (kPa)	TT/TL
							0km/h	5km/h	10km/h	25km/h		
18.00-25	IND-4	40	13.00/2.5	70.0	1675	515	31500	25400	23600	21900	1000	TL



# SM05

Port Service

Size	TRA Code	Ply Rating	Standard Rim	Tread Depth (mm)	Overall Diameter (mm)	Section Width (mm)	Load Capacity at various speed (kg)				Cold Inflation Pressure (kPa)	TT/TL
							0km/h	5km/h	10km/h	25km/h		
18.00-25	IND-4	40	13.00/2.5	90.0	1675	515	31500	25400	23600	21900	1000	TL



# SM04

Port Service

Size	TRA Code	Ply Rating	Standard Rim	Tread Depth (mm)	Overall Diameter (mm)	Section Width (mm)	Load Capacity at various speed (kg)				Cold Inflation Pressure (kPa)	TT/TL
							0km/h	5km/h	10km/h	25km/h		
18.00-25	IND-4	40	13.00/2.5	60	1675	515	31500	25400	23600	21900	1000	TL

# OFF-THE-ROAD TYRES-BIAS

# OFF-THE-ROAD TYRES-BIAS



## EL27

Port Service

Size	TRA Code	Ply Rating	Standard Rim	Tread Depth (mm)	Overall Diameter (mm)	Section Width (mm)	Load Capacity at various speed (kg)				Cold Inflation Pressure (kPa)	TT/TL
							0km/h	5km/h	10km/h	25km/h		
16.00-25	IND-3	32	11.25/2.0	32.0	1495	430	22500	18100	16900	15600	1000	TL
	IND-3	36	11.25/2.0	32.0	1495	430	24500	19700	18400	17000	1000	TL
18.00-25	IND-3	40	13.00/2.5	36.0	1610	510	30600	24600	23000	21200	1000	TL
	IND-3	44	13.00/2.5	36.0	1610	510	32700	26300	24500	22700	1000	TL
	IND-3	48	13.00/2.5	36.0	1610	510	36000	29000	27000	25000	1000	TL
21.00-25	IND-3	40	15.00/3.0	36.0	1750	575	36400	29300	27300	/	1000	TL
	IND-3	44	15.00/3.0	36.0	1750	575	38900	31100	29200	/	1000	TL
21.00-35	IND-3	40	15.00/3.0	38.0	2005	570	43700	35200	32800	30400	1000	TL



## EL29

Port Service

Size	TRA Code	Ply Rating	Standard Rim	Tread Depth (mm)	Overall Diameter (mm)	Section Width (mm)	Load Capacity at various speed (kg)				Cold Inflation Pressure (kPa)	TT/TL
							0km/h	5km/h	10km/h	25km/h		
14.00-24	IND-3	28	10	30.0	1370	375	18000	14500	13500	12000	1000	TT/TL
	IND-3	32	10	30.0	1370	375	18450	14850	13850	12800	1000	TL



## EL39

Port Service

Size	TRA Code	Ply Rating	Standard Rim	Tread Depth (mm)	Overall Diameter (mm)	Section Width (mm)	Max. Load Capacity (kg)	Cold Inflation Pressure (kPa)	TT/TL
11.00-20	E-3	16	8.0	28.0	1105	293	5165	800	TT
	E-3	18	8.0	28.0	1105	293	5535	900	TT
12.00-20	E-3	18	8.5	28.0	1145	315	5915	800	TT
	E-3	20	8.5	28.0	1145	315	6335	900	TT



## EL57

Port Service

Size	TRA Code	Ply Rating	Standard Rim	Tread Depth (mm)	Overall Diameter (mm)	Section Width (mm)	Load Capacity at various speed (kg)				Cold Inflation Pressure (kPa)	TT/TL
							0km/h	5km/h	10km/h	25km/h		
12.00-24	IND-4	24	8.5	43.5	1245	315	12300	10800	9300	7100	1000	TT



## CL991

Port Service

Size	TRA Code	Ply Rating	Standard Rim	Tread Depth (mm)	Overall Diameter (mm)	Section Width (mm)	Max. Load Capacity (kg)	Cold Inflation Pressure (kPa)	TT/TL
11.00-20	-	18	8.0	30	1105	293	3650	840	TT
12.00-20	-	20	8.5	30	1145	315	4000	880	TT



## OFF-THE-ROAD TYRES-BIAS

# OFF-THE-ROAD TYRES-BIAS Industrial Service-Forklift



## GA69

Industrial Service-Forklift

Size	TRA Code	Ply Rating	Service Index	Standard Rim	Tread Depth (mm)	Overall Diameter (mm)	Section Width (mm)	Max. Load Capacity (kg)	Cold Inflation Pressure (kPa)	TT/TL
5.00-8(B)	-	10	-	3.50D	11.0	470	137	1150	1000	TT
18x7-8(B)	-	14/16	-	4.00E	13.0	4650	173	1505	970	TT
6.00-9(B)	-	10/12	-	5.00S	13.0	540	160	1505	860	TL
7.00-9(B)	-	10	-	5.00S	13.0	590	190	1995	860	TT
650-10(B)	-	10	-	5.00F	14.0	590	175	1655	790	TT
7.00-12(B)	-	12/14	-	6.5	17	676	190	2375/2590	860/1000	TT
8.25-12(B)	-	12	-	6.5	16.5	765	235	3060	720	TT
8.25-15(B)	-	14/16	-	4.33R	19.0	840	235	3775/4050	830/925	TT
250-15(B)	-	16/18+	-	7.5	23.5	735	250	3865/4110	930/1030	TT
300-15(B)	-	20	-	8.0	23.0	840	300	5940	930	TT
28x9-15(B)	-	14	-	7.0	16	710	220	3050	970	TT



## CL618

Industrial Service-Forklift

Size	TRA Code	Ply Rating	Service Index	Standard Rim	Tread Depth (mm)	Overall Diameter (mm)	Section Width (mm)	Max. Load Capacity (kg)	Cold Inflation Pressure (kPa)	TT/TL
4.00-8	-	6	-	3.00D	7.0	415	112	640	720	TT
7.00-9	-	10	-	5.00S	10.0	590	190	1995	860	TT
8.25-12	-	12	-	5.00S	13.0	728	210	2000	700	TT



# CL619

Industrial Service-Forklift

Size	TRA Code	Ply Rating	Service Index	Standard Rim	Tread Depth (mm)	Overall Diameter (mm)	Section Width (mm)	Max. Load Capacity (kg)	Cold Inflation Pressure (kPa)	TT/TL
5.00-8	-	10	-	3.50D	12.0	470	137	1150	1000	TT
6.00-9	-	8	-	4.00E	13.0	540	160	1315	690	TT
6.50-10	-	10	-	4.00E	13.0	540	160	1505	860	TT
7.00-12	-	10	-	5.00F	13.0	590	175	1655	790	TT
7.00-12	-	12	-	5.00S	15.0	676	190	2375	860	TT
7.00-15	-	12	-	5.5	15.0	750	200	2870	860	TT
7.50-15	-	12	-	6.0	17.0	780	215	3075	790	TT
8.25-15	-	14	-	6.5	16.0	840	235	3775	830	TT
8.25-15	-	16	-	6.5	16.0	840	235	4330	900	TT
18x7-8	-	16	-	4.33R	14.0	173	465	1640	1000	TT
21x8-9	-	14	-	6.00E	15.5	535	200	2040	1000	TT
23x9-10	-	18	-	6.50F	16.0	595	225	3160	1050	TT
28x9-15	-	14	-	7.0	13.0	710	220	3050	970	TT
28x9-15	-	16	-	7.0	13.0	710	220	3115	1000	TT
250-15	-	16	-	7.5	21.5	735	250	3865	930	TT
300-15	-	18	-	8.0	22.0	840	300	5530	830	TT
300-15	-	20	-	8.0	22.0	840	300	5940	930	TT



# CL621

Industrial Service-Forklift

Size	TRA Code	Ply Rating	Service Index	Standard Rim	Tread Depth (mm)	Overall Diameter (mm)	Section Width (mm)	Max. Load Capacity (kg)	Cold Inflation Pressure (kPa)	TT/TL
5.00-8	-	10	-	3.50D	11.0	470	137	1150	1000	TT
6.00-9	-	10	-	4.00E	12.5	540	160	1505	860	TT
7.00-9	-	10	-	5.00S	10.0	590	190	1995	860	TT
6.50-10	-	10	-	5.00F	12.0	590	175	1655	790	TT
7.00-12	-	12	-	5.00S	13.0	676	190	2375	860	TT
8.25-12	-	12	-	6.5	19.0	765	235	3060	720	TT
6.00-15	-	10+	-	4.50E	14.0	705	170	2185	830	TT
8.25-15	-	14	-	6.5	16.0	840	235	3775	830	TT
9.00-16	-	14	-	6.50H	16.0	890	255	4495	760	TT
8.25-20	-	14	-	6.5	15.0	974	235	3865	830	TT
9.00-20	-	16	-	7.0	17	1018	259	4715	860	TT
18x7-8	-	14	-	4.33R	16.0	173	465	1440	900	TT
23x9-10	-	18	-	6.50F	14.0	595	225	3160	1050	TT
27x10-12	-	14	-	8.00G	14.0	690	255	3210	720	TT
28x9-15	-	14	-	7.0	16.0	710	220	3050	970	TT
250-15	-	16	-	7.5	21.0	735	250	3865	930	TT
300-15	-	18+	-	8.0	23.0	840	300	5530	830	TT



# CL622

Industrial Service-Forklift

Size	TRA Code	Ply Rating	Service Index	Standard Rim	Tread Depth (mm)	Overall Diameter (mm)	Section Width (mm)	Max. Load Capacity (kg)	Cold Inflation Pressure (kPa)	TT/TL
10.00-20	-	16	-	7.5	22.0	1073	278	-	800	TT
12.00-20	-	16	-	8.5	25.0	1145	315	-	700	TT
12.00-20	-	18	-	8.5	25.0	1145	315	-	700	TT



# CL628

Industrial Service-Forklift

Size	TRA Code	Ply Rating	Service Index	Standard Rim	Tread Depth (mm)	Overall Diameter (mm)	Section Width (mm)	Max. Load Capacity (kg)	Cold Inflation Pressure (kPa)	TT/TL
6.00-9(B)	-	10	-	4.00E	13.0	540	160	1505	860	TT
6.50-10(B)	-	10	-	5.00F	15.0	590	175	1655	790	TT
7.00-12(B)	-	12	-	5.00S	17.0	676	190	2375	860	TT
8.25-12(B)	-	12	-	6.5	16.5	765	235	3060	720	TT
8.25-15(B)	-	14	-	6.5	15.5	840	235	3775	830	TT
28x9-15(B)	-	14	-	7.0	16.0	710	220	3050	970	TT
300-15(B)	-	18+	-	8.0	23.0	840	300	5530	830	TT

## OFF-THE-ROAD TYRES-BIAS



### CL623

Industrial Service-Forklift

Size	TRA Code	Ply Rating	Service Index	Standard Rim	Tread Depth (mm)	Overall Diameter (mm)	Section Width (mm)	Max. Load Capacity (kg)	Cold Inflation Pressure (kPa)	TT/TL
9.00-16	-	14	-	6.50H	15.0	890	255	4495	760	TT



### CL626

Industrial Service-Forklift

Size	TRA Code	Ply Rating	Service Index	Standard Rim	Tread Depth (mm)	Overall Diameter (mm)	Section Width (mm)	Max. Load Capacity (kg)	Cold Inflation Pressure (kPa)	TT/TL
10.00-20	-	18	-	7.5	26.5	1099	278	6755	910	TT
12.00-20	-	20	-	8.5	26.5	1173	315	8055	880	TT



### EDT

Industrial Service-Forklift

Size	TRA Code	Ply Rating	Service Index	Standard Rim	Tread Depth (mm)	Overall Diameter (mm)	Section Width (mm)	Max. Load Capacity (kg)	Cold Inflation Pressure (kPa)	TT/TL
5.00-8	-	10	-	3.50D	17.5	470	137	1150	1000	TT
6.00-9	-	12	-	4.00E	19.3	540	160	1675	1030	TT
6.50-10	-	12	-	5.00F	23.8	590	175	1860	790	TT
7.00-12	-	14	-	5.00S	22.0	676	190	2590	1000	TT
7.00-15	-	14	-	5.5	23.0	750	200	3140	1000	TT
7.50-15	-	14	-	6.0	21.5	780	215	3375	925	TT
8.25-15	-	14	-	6.5	24.5	840	235	3775	830	TT
28x9-15	-	14	-	7.0	20.6	710	220	3050	970	TT



## OFF-THE-ROAD TYRES-SOLID Resilent

# OFF-THE-ROAD TYRES-SOLID

# OFF-THE-ROAD TYRES-SOLID



## CL402(S)

Resilient

Size	Tread Depth (mm)	Standard Rim	Overall Diameter (mm)	Section Width (mm)	Max. Load (kg)										Tire Weight (kg)
					6mph/10km/h		10mph/16km/h		15mph/25km/h		Other Vehicles				
					Load	Steer	Load	Steer	Load	Steer	0mph/0mph	4mph/6km/h	6mph/10km/h	15mph/25km/h	
5.00-8	25	3.00D	460	128	1255	965	1145	880	1060	815	1305	1060	960	815	17.7
	25	3.25I	460	128	1360	1045	1235	950	1150	885	1415	1150	1045	885	18.0
	25	3.75	460	128	1570	1205	1430	1100	1325	1020	1630	1325	1200	1020	18.1
6.00-9	25	4.00E	523	146	1975	1520	1805	1390	1675	1290	2065	1675	1520	1290	26.5
6.50-10	25	5.00F	574	156	2715	2090	2485	1910	2310	1775	2840	2310	2095	1775	33.6
	25	5.50F	574	156	2985	2300	2735	2100	2540	1950	3125	2540	2305	1950	34.0
7.00-12	25	5.00S	655	160	3105	2390	2835	2180	2635	2025	3240	2635	2390	2025	45.5
	25	5.50	730	180	3700	2845	3375	2595	3135	2410	3855	3135	2845	2410	57.0
7.00-15	25	6.00	730	180	4035	3105	3680	2830	3420	2630	4205	3420	3105	2630	58.0
	30	5.50	820	207	4305	3310	3925	3020	3640	2800	4480	3640	3305	2800	86.5
8.25-15	30	6.50	820	207	5085	3910	4640	3570	4310	3315	5304	4310	3910	3315	87.0



## CL404(S)/CL406(S)

Resilient

Size	Tread Depth (mm)	Standard Rim	Overall Diameter (mm)	Section Width (mm)	Max. Load (kg)										Tire Weight (kg)
					6mph/10km/h		10mph/16km/h		15mph/25km/h		Other Vehicles				
					Load	Steer	Load	Steer	Load	Steer	0mph/0mph	4mph/6km/h	6mph/10km/h	15mph/25km/h	
9.00-16(CL404S)	25	6.50H	860	230	5290	4070	4830	3715	4485	3450	5520	4485	4070	3450	112.0
	25	7.00N	860	230	5695	4385	5200	4000	4830	3715	5945	4830	4385	3715	112.0
10.00-20(CL404S)	25	7.00	1042	260	6845	5705	6260	5215	5815	4845	7270	5815	5280	4845	184.0
	25	7.50	1042	260	7075	5895	6460	5385	6000	5000	7500	6500	5450	5000	185.0
	25	8.00	1042	260	7300	6085	6670	5560	6200	5165	7750	6715	5630	5165	186.0
12.00-20(CL404S)	25	8.00	1120	290	8640	7200	7885	6570	7320	6100	9150	7930	6650	6100	241.0
	25	8.50	1120	290	8920	7435	8140	6785	7560	6300	9450	8190	6865	6300	242.0
12.00-24(CL404S)	30	8.50	1216	306	9125	7605	8335	6945	7740	6450	9675	8385	7030	6450	283.6
30x10-20(CL406S)	33	7.50	762	254	-	-	-	-	-	-	3990	3458	2900	2660	71.3
33x10.75-20(CL406S)	33	7.50	832	272	-	-	-	-	-	-	4425	3835	3215	2950	99.5



## CL403(S)

Resilient

Size	Tread Depth (mm)	Standard Rim	Overall Diameter (mm)	Section Width (mm)	Max. Load (kg)										Tire Weight (kg)
					6mph/10km/h		10mph/16km/h		15mph/25km/h		Other Vehicles				
					Load	Steer	Load	Steer	Load	Steer	0mph/0mph	4mph/6km/h	6mph/10km/h	15mph/25km/h	
4.00-8	20	3.00D	405	105	1090	840	995	765	925	710	1135	925	840	710	12.5
	20	3.75	405	105	1175	905	1080	830	1000	770	1230	1000	910	770	12.5
5.00-8	25	3.00D	456	126	1255	965	1145	880	1060	815	1305	1060	960	815	17.0
15x4/2-8(125/75-8)	20	3.00D	380	104	1005	775	915	705	850	655	1050	850	775	655	9.5
	20	3.25I	380	104	1090	840	995	765	925	710	1135	925	835	710	9.5
16x6-8(150/75-8)	20	4.33R	406	146	1545	1190	1410	1085	1305	1005	1610	1305	1185	1005	15.5
18x7-8(180/70-8)	25	4.33R	455	158	2430	1870	2215	1705	2060	1585	2535	2060	1870	1585	22.0
6.00-9	25	4.00E	525	146	1975	1520	1805	1390	1675	1290	2065	1675	1520	1290	26.5
7.00-9	30	5.00S	550	168	2670	2055	2440	1875	2260	1740	2785	2260	2055	1740	35.0
21x8-9(200/75-9)	25	6.00E	518	182	2890	2225	2645	2035	2455	1890	3025	2455	2230	1890	33.0
6.50-10	25	5.00F	570	156	2715	2090	2485	1910	2310	1775	2840	2310	2095	1775	33.8
200/50-10	20	6.50F	457	196	2910	2240	2665	2050	2470	1900	3040	2470	2240	1900	25.0
23x9-10(225/75-10)	25	6.50F	580	200	3730	2870	3405	2620	3160	2430	3890	3160	2865	2430	46.0
7.00-12	30	5.00S	654	170	3105	2390	2835	2180	2635	2025	3240	2635	2390	2025	46.5
	30	6.50	660	229	3926	3020	3590	2760	3330	2560	3840	3330	3020	2560	63.3
8.25-12	35	5.00S	720	195	3425	2635	3125	2405	2905	2235	3575	2905	2635	2235	64.2
23x10-12(250/60-12)	25	8.00G	585	240	4450	3425	4060	3125	3770	2900	4640	3770	3420	2900	51.8
27x10-12(250/75-12)	30	8.00G	676	240	4595	3535	4200	3230	3900	3000	4800	3900	3540	3000	72.0
250-15(250/70-15)	30	7.00	720	236	5220	4015	4770	3670	4425	3405	5450	4425	4015	3405	73.0
	30	7.50	720	236	5595	4305	5110	3930	4745	3650	5840	4745	4305	3650	73.5
300-15(315/70-15)	30	8.00	813	254	6895	5305	6300	4845	5850	4500	7200	5850	5310	4500	108.0
	30	5.50	750	190	3805	2925	3470	2670	3225	2480	3970	3225	2925	2480	68.0
	30	6.50	750	190	4490	3455	4100	3155	3810	2930	4690	3810	3455	2930	69.0
8.25-15	35	5.50	818	203	4305	3310	3925	3020	3640	2800	4480	3640	3305	2800	88.5
	35	6.50	818	203	5085	3910	4640	3570	4310	3315	5304	4310	3910	3315	88.5
28x9-15(225/75-15)(8.15-15)	25	6.50	700	215	3770	2900	3445	2650	3200	2460	3935	3200	2900	2460	60.9
	25	7.00	700	215	4060	3125	3710	2855	3445	2650	4240	3445	3125	2650	60.9
28x12.5-15(315/50-15)	30	9.75	706	300	6200	4770	5660	4355	5260	4045	6470	5260	4775	4045	88.8
32x12.1-15(355/65-15)	30	9.75	808	290	-	-	-	-	7800	6000	9600	7085	6430	5450	123.0
6.50-16	30	5.50	742	173	3545	2725	3235	2490	3005	2310	3695	3005	2725	2310	57.6
	30	5.50F	814	190	4035	3105	3685	2835	3425	2635	4215	3425	3110	2635	78
7.50-16	30	6.00G	814	190	4400	3385	4025	3095	3730	2870	4590	3730	3385	2870	78.8
	30	5.50F	820	205	4070	3130	3720	2860	3450	2655	4250	3450	3135	2655	86.5
9.00-16	35	5.50F	846	230	4480	3445	4090	3145	3795	2920	4670	3795	3445	2920	102.6
	45	6.50	960	220	5165	4305	4715	3930	4380	3650	5475	4745	3980	3650	123.0
8.25-20	45	7.00	960	220	5335	4445	4870	4060	4525	3770	5655	4900	4110	3770	123.6
	45	6.50	1010	246	6160	5135	5630	4690	5225	4355	6535	5660	4745	4355	149.0
9.00-20	45	7.00	1010	246	6365	5305	5815	4845	5400	4500	6750	5850	4905	4500	151.0
	45	7.00	1010	246	6845	5705	6260	5215	5815	4845	7270	5815	5280	4845	151.0
10.00-20	45	7.50	1010	246	7075	5895	6460	5385	6000	5000	7500	6500	5450	5000	153.0
	45	8.00	1010	246	7300	6085	6670	5560	6200	5165	7750	6715	5630	5165	155.0
	45	8.00	1085	280	7715	6430	7045	5870	6540	5450	8175	7085	5940	5450	218.0
11.00-20	45	8.00	1088	260	8640	7200	7885	6570	7320	6100	9150	7930	6650	6100	195.0
	45	8.50	1088	260	8920	7435	8140	6785	7560	6300	9450	8190	6865	6300	197.0
14.00-20	45	10.00W	1278	362	11630	9690	10620	8850	9860	8215	12320	9860	8955	8215	408.0
14.00-24	35	10.00	1300	324	12165	10135	11105	9255	10315	8595	12890	11175	9370	8595	354.0

# OFF-THE-ROAD TYRES-SOLID

# OFF-THE-ROAD TYRES-SOLID



## CL408

Resilent

Size	Tread Depth (mm)	Standard Rim	Overall Diameter (mm)	Section Width (mm)	Max. Load (kg)										Tire Weight (kg)
					6mph/10km/h		10mph/16km/h		15mph/25km/h		Other Vehicles				
					Load	Steer	Load	Steer	Load	Steer	0mph/0mph	4mph/6km/h	6mph/10km/h	15mph/25km/h	
6.50-10	26.0	5.00F	575	160	2715	2090	2485	1910	2310	1775	2840	2310	2095	1775	33.5
7.00-15	35.0	5.5	730	196	3700	2845	3375	2595	3135	2410	3855	3135	2845	2410	57
	35.0	6.0	730	196	4035	3105	3680	2830	3420	2630	4205	3420	3105	2630	58
28x9-15	30.0	7.0	700	216	4060	3125	3710	2855	3445	2650	4240	3445	3125	2650	60.3
8.15-15	30.0	7.0	700	216	4060	3125	3710	2855	3445	2650	4240	3445	3125	2650	60.3
225/75-15	30.0	7.0	700	216	4060	3125	3710	2855	3445	2650	4240	3445	3125	2650	60.3



## GHT01(S)

Resilent

Size	Tread Depth (mm)	Standard Rim	Overall Diameter (mm)	Section Width (mm)	Max. Load (kg)										Tire Weight (kg)
					6mph/10km/h		10mph/16km/h		15mph/25km/h		Other Vehicles				
					Load	Steer	Load	Steer	Load	Steer	0mph/0mph	4mph/6km/h	6mph/10km/h	15mph/25km/h	
3.50-5	13	3.00	298	102	760	610	735	550	685	515	770	670	605	515	6.0
5.00-8	18	3.00D	450	130	1255	965	1145	880	1060	815	1305	1060	960	815	17.0
	18	3.50D	450	130	1465	1125	1335	1025	1235	950	1520	1235	1120	950	17.0
16x6-8(150/75-8)	15	4.33R	412	152	1545	1190	1410	1085	1305	1005	1610	1305	1185	1005	16.0
18x7-8(180/70-8)	18	4.33R	456	162	2430	1870	2215	1705	2060	1585	2535	2060	1870	1585	22.0
6.00-9	18	4.00E	525	150	1975	1520	1805	1390	1675	1290	2065	1675	1520	1290	26.8
7.00-9	20	5.00S	550	168	2670	2055	2440	1875	2260	1740	2785	2260	2055	1740	34.0
21x8-9(200/75-9)	18	6.00E	518	182	2890	2225	2645	2035	2455	1890	3025	2455	2230	1890	34.4
6.50-10	18	5.00F	570	160	2715	2090	2485	1910	2310	1775	2840	2310	2095	1775	34.5
23x9-10(225/75-10)	25	6.50F	580	210	3730	2870	3405	2620	3160	2430	3890	3160	2865	2430	46.6
7.00-12	18	5.00S	654	170	3105	2390	2835	2180	2635	2025	3240	2635	2390	2025	46.5
8.25-12	25	5.00S	720	190	3425	2635	3125	2405	2905	2235	3575	2905	2635	2235	65.0
5.50-15	22	4.50E	672	150	2525	1870	2415	1790	2195	1625	2435	2110	1715	1625	38.8
6.00-15	22	4.50E	710	164	2830	2095	2705	2000	2455	1820	2730	2365	2145	1820	48.2
7.00-15	25	5.50	736	194	3700	2845	3375	2595	3135	2410	3855	3135	2845	2410	64.5
	25	6.00	736	194	4035	3105	3680	2830	3420	2630	4205	3420	3105	2630	65.0
8.25-15	25	5.50	820	212	4305	3310	3925	3020	3640	2800	4480	3640	3305	2800	92.0
	25	6.50	820	212	5085	3910	4640	3570	4310	3315	5304	4310	3910	3315	92.6
28x9-15(225/75-15)	20	6.50	700	215	3770	2900	3445	2650	3200	2460	3935	3200	2900	2460	63.0
	20	7.00	700	215	4060	3125	3710	2855	3445	2650	4240	3445	3125	2650	63.6
300-15(315/70-15)	25	8.00	813	256	6895	5305	6300	4845	5850	4500	7200	5850	5310	4500	108.4
8.25-20	30	6.50	960	220	5165	4305	4715	3930	4380	3650	5475	4745	3980	3650	123.0
	30	7.00	960	220	5335	4445	4870	4060	4525	3770	5655	4900	4110	3770	123.8
9.00-20	30	6.50	1010	235	6160	5135	5630	4690	5225	4355	6535	5660	4745	4355	147.5
	30	7.00	1010	235	6365	5305	5815	4845	5400	4500	6750	5850	4905	4500	148.2



## GHT01H

Resilent

Size	Tread Depth (mm)	Standard Rim	Overall Diameter (mm)	Section Width (mm)	Max. Load (kg)										Tire Weight (kg)
					6mph/10km/h		10mph/16km/h		15mph/25km/h		Other Vehicles				
					Load	Steer	Load	Steer	Load	Steer	0mph/0mph	4mph/6km/h	6mph/10km/h	15mph/25km/h	
6.00-9	18	4.00E	525	150	1975	1520	1805	1390	1675	1290	2065	1675	1520	1290	25.0
6.50-10	18	5.00F	570	160	2715	2090	2485	1910	2310	1775	2840	2310	2095	1775	33.0
7.00-12	18	5.00S	654	170	3105	2390	2835	2180	2635	2025	3240	2635	2390	2025	45.0
250-15(250/70-15)	20	7.00	720	236	5220	4015	4770	3670	4425	3405	5450	4425	4015	3405	73.0
	20	7.50	720	236	5595	4305	5110	3930	4745	3650	5840	4745	4305	3650	73.5
300-15(315/70-15)	25	8.00	815	264	6895	5305	6300	4845	5850	4500	7200	5850	5310	4500	115.0
7.00-15	25	5.50	736	194	3700	2845	3375	2595	3135	2410	3855	3135	2845	2410	61.0
	25	6.00	736	194	4035	3105	3680	2830	3420	2630	4205	3420	3105	2630	61.6
8.25-15	25	5.50	820	212	4305	3310	3925	3020	3640	2800	4480	3640	3305	2800	89.0
	25	6.50	820	212	5085	3910	4640	3570	4310	3315	5304	4310	3910	3315	89.0
28x9-15	20	6.50	700	215	3770	2900	3445	2650	3200	2460	3935	3200	2900	2460	60.7
	20	7.00	700	215	4060	3125	3710	2855	3445	2650	4240	3445	3125	2650	61.0

# OFF-THE-ROAD TYRES-SOLID

# OFF-THE-ROAD TYRES-SOLID



## RIB01/RIB01H/RIB01S/RIB02S

Resilent

Size	Tread Depth (mm)	Standard Rim	Overall Diameter (mm)	Section Width (mm)	Max. Load (kg)										Tire Weight (kg)
					6mph/10km/h		10mph/16km/h		15mph/25km/h		Other Vehicles				
					Load	Steer	Load	Steer	Load	Steer	0mph/0mph	4mph/6km/h	6mph/10km/h	15mph/25km/h	
3.20-8(RIB01S)	2	3.00D	325	110	760	585	695	535	645	495	740	645	585	495	6.0
4.00-8(RIB01S)	4	3.00D	405	105	1090	840	995	765	925	710	1135	925	840	710	11.5
	4	3.75	405	105	1175	905	1080	830	1000	770	1230	1000	910	770	11.5
4.00-8(RIB02S)	4	3.00D	395	100	1090	840	995	765	925	710	1135	925	840	710	9.6
4.00-8(RIB01H)	4	3.75	405	105	1175	905	1080	830	1000	770	1230	1000	910	770	11.3
15x4 1/2-8(RIB01S)	4	3.00D	380	104	1005	775	915	705	850	655	1050	850	775	655	8.6
	4	3.25I	380	104	1090	840	995	765	925	710	1135	925	835	710	8.6
16x5-9(RIB01S)	3.5	3.50	408	120	1170	900	1070	825	995	765	1145	995	900	765	11.4
40x14-16(RIB01)	8	11	1006	356	-	-	-	-	-	-	10635	9215	8365	7090	252.9



## SR01/SR01H

Resilent

Size	Tread Depth (mm)	Standard Rim	Overall Diameter (mm)	Section Width (mm)	Max. Load (kg)										Tire Weight (kg)
					6mph/10km/h		10mph/16km/h		15mph/25km/h		Other Vehicles				
					Load	Steer	Load	Steer	Load	Steer	0mph/0mph	4mph/6km/h	6mph/10km/h	15mph/25km/h	
20.5-25(SR01)	80	17.0/2.0	1480	520	-	-	-	-	-	-	9600	11600	10560	9600	776
23.5-25(SR01)	90	19.5/2.5	1610	590	-	-	-	-	-	-	12000	14400	13200	12000	1066
26.5-25(SR01)	100	22.0/3.0	1720	650	-	-	-	-	-	-	14500	17550	15950	14500	1345
20.5-25(SR01H)	80	17.0/2.0	1480	520	-	-	-	-	-	-	9600	11600	10560	9600	766
23.5-25(SR01H)	90	19.5/2.5	1610	590	-	-	-	-	-	-	12000	14400	13200	12000	1046
26.5-25(SR01H)	100	22.0/3.0	1720	650	-	-	-	-	-	-	14500	17550	15950	14500	1322



## SM/SMH

Resilent

Size	Tread Depth (mm)	Standard Rim	Overall Diameter (mm)	Section Width (mm)	Max. Load (kg)										Tire Weight (kg)
					6mph/10km/h		10mph/16km/h		15mph/25km/h		Other Vehicles				
					Load	Steer	Load	Steer	Load	Steer	0mph/0mph	4mph/6km/h	6mph/10km/h	15mph/25km/h	
26x9-15(SM)	-	7.0	650	205	3770	2900	3440	2645	3190	2455	3680	3190	2895	2455	51.9
6.50-16(SM)	-	5.50F	744	190.5	3545	2725	3235	2490	3005	2310	3695	3005	2725	2310	58.2
8.25-20(SM)	-	6.50	919.5	221	5165	4305	4175	3930	4380	3650	5475	4745	3980	3650	99.9
10.00-20(SM)	-	7.50	1020	240	7075	5895	6460	5385	6000	5000	7500	6500	5450	5000	162.0
11.00-20(SM)	-	8.00	1062	270	7715	6430	7045	5870	6540	5450	8175	7085	5940	5450	206.0
31x10-20(10-16.5)(SM)	-	7.50	776	254	-	-	-	-	-	-	4200	3640	3050	2800	75.0
31x10-20(10-16.5)(SMH)	-	7.50	776	254	-	-	-	-	-	-	4200	3640	3050	2800	72.0
33x12-20(12-16.5)(SM)	-	7.50	828	290	-	-	-	-	-	-	4650	4030	3380	3100	102.0
33x12-20(12-16.5)(SMH)	-	7.50	828	290	-	-	-	-	-	-	4650	4030	3380	3100	99.0
36x14-20(14-17.5)(SM)	-	7.50	906	328	-	-	-	-	-	-	5760	4610	4185	3840	144.0
36x14-20(14-17.5)(SMH)	-	7.50	906	328	-	-	-	-	-	-	5760	4610	4185	3840	144.0



## SR02/SR02H

Resilent

Size	Tread Depth (mm)	Standard Rim	Overall Diameter (mm)	Section Width (mm)	Max. Load (kg)										Tire Weight (kg)
					6mph/10km/h		10mph/16km/h		15mph/25km/h		Other Vehicles				
					Load	Steer	Load	Steer	Load	Steer	0mph/0mph	4mph/6km/h	6mph/10km/h	15mph/25km/h	
31x10-20(10-16.5)(SR02)	38	7.50	776	254	-	-	-	-	-	-	4200	3640	3050	2800	72.0
31x10-20(10-16.5)(SR02H)	38	7.50	776	254	-	-	-	-	-	-	4200	3640	3050	2800	66.0
33x12-20(12-16.5)(SR02)	40	7.50	828	290	-	-	-	-	-	-	4650	4030	3380	3100	99.0
33x12-20(12-16.5)(SR02H)	40	7.50	828	290	-	-	-	-	-	-	4650	4030	3380	3100	96.0
36x14-20(14-17.5)(SR02)	45	7.50	906	330	-	-	-	-	-	-	5760	4610	4185	3840	133.0
36x14-20(14-17.5)(SR02H)	45	7.50	906	330	-	-	-	-	-	-	5760	4610	4185	3840	129.0
385/65-24(SR02H)	50	10.00	1060	360	-	-	-	-	-	-	9030	7225	6560	6020	202.0



## SR08/SR08H

Resilent

Size	Tread Depth (mm)	Standard Rim	Overall Diameter (mm)	Section Width (mm)	Max. Load (kg)										Tire Weight (kg)		
					6mph/10km/h		10mph/16km/h		15mph/25km/h		Other Vehicles						
					Load	Steer	Load	Steer	Load	Steer	0mph/0mph	4mph/6km/h	6mph/10km/h	15mph/25km/h			
23.5-25(SR08)	90	19.5/2.5	1592	590	-	-	-	-	-	-	-	-	-	-	13600	-	1050
23.5-25(SR08H)	90	19.5/2.5	1592	590	-	-	-	-	-	-	-	-	-	-	13600	-	1030



## SR03H/SR04

Resilent

Size	Tread Depth (mm)	Standard Rim	Overall Diameter (mm)	Section Width (mm)	Max. Load (kg)										Tire Weight (kg)
					6mph/10km/h		10mph/16km/h		15mph/25km/h		Other Vehicles				
					Load	Steer	Load	Steer	Load	Steer	0mph/0mph	4mph/6km/h	6mph/10km/h	15mph/25km/h	
13.00-24(SR03H)	36	8.5	1260	306	-	-	-	-	-	-	9840	7870	7150	6560	278.1
14.00-24(SR03H)	36	8.5	1359	356	-	-	-	-	-	-	12890	11175	9370	8595	375.8
385/65-24(SR04)	36	10.0	1060	360	-	-	-	-	-	-	9030	7225	6560	6020	220.0



# OFF-THE-ROAD TYRES-SOLID



## SR60

Resilent

Size	Tread Depth (mm)	Standard Rim	Overall Diameter (mm)	Section Width (mm)	Max. Load (kg)										Tire Weight (kg)
					6mph/10km/h		10mph/16km/h		15mph/25km/h		Other Vehicles				
					Load	Steer	Load	Steer	Load	Steer	0mph/0mph	4mph/6km/h	6mph/10km/h	15mph/25km/h	
5.00-8	15	3.00D	450	123	1255	965	1145	880	1060	815	1350	1060	960	815	16.6
6.00-9	18	4.00E	525	146	1975	1520	1805	1390	1675	1290	2065	1675	1520	1290	26.5
6.50-10	20	5.00F	575	156	2715	2090	2485	1910	2310	1775	2840	2310	2095	1775	34.2
7.00-12	20	5.00S	654	169	3105	2390	2835	2180	2635	2025	3240	2635	2390	2025	44.5
15x41/2-8(125/75-8)	12	3.00D	380	105	1005	775	915	705	850	655	1050	850	775	655	8.8
16x6-8(150/75-8)	15	4.33R	418	150	1545	1190	1410	1085	1305	1005	1610	1305	1185	1005	16.0
18x7-8(180/70-8)	15	4.33R	454	165	2430	1870	2215	1705	2060	1585	2535	2060	1870	1585	20.9
21x8-9(200/75-9)	18	6.00E	518	182	2890	2225	2645	2035	2455	1890	3025	2455	2230	1890	30.1
200/50-10	16	6.50F	457	190	2910	2240	2665	2050	2470	1900	3040	2470	2240	1900	23.7
23x9-10(225/75-10)	20	6.50F	580	190	3730	2870	3405	2620	3160	2430	3890	3160	2865	2430	43.2
23x10-12(250/60-12)	20	8.00G	585	238	4450	3425	4060	3125	3770	2900	4640	3770	3420	2900	50.5
28x9-15(225/75-15)	25	7.0	694	210	4060	3125	3710	2855	3445	2650	4240	3445	3125	2650	58.9
28x12.5-15	25	9.75	694	300	6200	4770	5660	4355	5260	4045	6470	5260	4775	4045	85.0



## SR61

Resilent

Size	Tread Depth (mm)	Standard Rim	Overall Diameter (mm)	Section Width (mm)	Max. Load (kg)										Tire Weight (kg)
					6mph/10km/h		10mph/16km/h		15mph/25km/h		Other Vehicles				
					Load	Steer	Load	Steer	Load	Steer	0mph/0mph	4mph/6km/h	6mph/10km/h	15mph/25km/h	
5.00-8	22.0	3.00D	454	123	1255	956	1145	880	1060	815	1305	1060	960	815	16.6
6.00-9	25.5	4.00E	525	141	1975	1520	1805	1390	1675	1290	2065	1675	1520	1290	26.5
6.50-10	26.0	5.00F	575	156	2715	2090	2485	1910	2310	1775	2840	2310	2095	1775	34.2
7.00-12	27.5	5.00S	654	169	3105	2390	2835	2180	2635	2025	3240	2635	2390	2025	44.5
8.25-15	32.0	6.50	818	200	5085	3910	4640	3570	4310	3315	5304	4310	3910	3315	86.5
10.00-20	42.0	7.0	1002	250	6845	5705	6260	5215	5815	4845	7270	5815	5280	4845	150.6
10.00-20	42.0	7.5	1002	250	7075	5895	6460	5385	6000	5000	7500	6500	5450	5000	150.6
12.00-20	47.0	8.0	1081	265	8640	7200	7885	6570	7320	6100	9150	7930	6650	6100	197.6
12.00-20	47.0	8.5	1081	265	8920	7435	8140	6785	7560	6300	9450	8190	6865	6300	197.6
14.00-24	45.0	10.00	1346	342	12165	10135	11105	9255	10315	8595	12890	10175	9370	8595	410.9
14.00-25	45.0	11.25	1333	381	13210	11010	12060	10050	11200	9335	14000	11200	10175	9335	430.0
18x7-8(180/70-8)	18.0	4.33R	455	152	2430	1870	2215	1705	2060	1585	2535	2060	1870	1585	20.9
28x9-15(225/75-15)	25.0	7.00	694	210	4060	3125	3710	2855	3445	2650	4240	3445	3125	2650	58.9
300-15(315/70-15)	34.0	8.00	814	242	6895	5305	6300	4845	5850	4500	7200	5850	5310	4500	106.6



# OFF-THE-ROAD TYRES-SOLID Press On

# OFF-THE-ROAD TYRES-SOLID

# OFF-THE-ROAD TYRES-SOLID



## SM/TR

Press On

Size	Overall Diameter (mm)	Section Width (mm)	Max. Load (kg)					Weight (kg)	
			6mph/10km/h		10mph/16km/h		Other Vehicles 10mph/16km/h	SM	TR
			Load	Steer	Load	Steer			
9x5x5	229	127	890	790	785	715	685	6.2	-
10x4 3/4x6 1/2	254	121	885	790	785	710	680	6.7	-
10x5x6 1/2	254	127	940	835	830	755	725	7.0	6.9
10 1/2x5x6 1/2	267	127	1000	890	885	805	770	7.8	-
12x4x8	305	102	835	745	740	670	645	7.4	-
12x4 1/2x8	305	114	970	865	860	780	745	8.4	-
12x5 1/2x8	305	140	1240	1100	1095	995	950	10.3	-
13 1/2x5 1/2x8	343	140	1400	1245	1235	1125	1075	13.4	12.3
14x4 1/2x8	356	114	1085	965	960	870	835	11.2	10.7
14x5x10	356	127	1240	1100	1095	995	955	11.5	-
15x4x11 1/4	381	102	985	875	870	790	755	10.2	-
15x5x11 1/4	381	127	1290	1150	1145	1040	995	12.1	-
16x5x10 1/2	406	127	1400	1245	1240	1125	1075	14.5	14.3
16x6x10 1/2	406	152	1775	1580	1570	1430	1365	17.6	17.1
16x7x10 1/2	406	178	2155	1915	1905	1730	1655	20.8	-
16 1/4x5x11 1/4	413	127	1415	1260	1250	1135	1090	14.5	14.1
16 1/4x6x11 1/4	413	152	1780	1585	1575	1430	1370	17.5	16.9
16 1/4x7x11 1/4	413	178	2150	1915	1900	1730	1655	20.8	20.0
17x5x12 1/8	432	127	1460	1300	1295	1175	1125	15.3	-
18x5x12 1/8	457	127	1525	1355	1350	1225	1175	17.5	16.8
18x6x12 1/8	457	152	1945	1735	1720	1565	1500	21.2	20.3
18x7x12 1/8	457	178	2370	2110	2095	1905	1820	24.4	23.9
18x8x12 1/8	457	203	2790	2485	2470	2245	2145	28.3	26.9
18x9x12 1/8	457	229	3215	2860	2840	2580	2470	-	34.0
21x6x15	533	152	2185	1945	1935	1760	1680	25.7	25.3
21x7x15	533	178	2665	2370	2355	2140	2050	30.0	29.3
21x8x15	533	203	3140	2795	2780	2525	2415	34.5	33.0
21x9x15	533	229	3620	3220	3200	2910	2785	39.4	-
20x5x16	508	127	1620	1440	1430	1300	1245	17.9	-
20x8x16	508	203	2795	2490	2475	2250	2150	28.8	27.6
22x8x16	559	203	3255	2895	2880	2615	2500	36.8	35.0
22x9x16	559	229	3745	3335	3315	3010	2880	45.1	42.9
22x10x16	559	254	4240	3775	3750	3410	3265	51.0	-
22x12x16	559	305	5230	4655	4625	4205	4025	61.3	60.3
22x14x16	559	356	6220	5535	5500	5000	4785	73.0	-
22x16x16	559	406	7205	6415	6375	5795	5545	83.0	-
28x12x22	711	305	6265	5575	5545	5035	4820	81.4	-
660x203x480	660	203	3740	3330	3310	3010	2880	54.5	-



## SM/TR

Press On

Size	Overall Diameter (mm)	Section Width (mm)	Max. Load (kg)					Weight (kg)	
			6mph/10km/h		10mph/16km/h		Other Vehicles 10mph/16km/h	SM	TR
			Load	Steer	Load	Steer			
9x5x5	229	127	890	790	785	715	685	6.4	-
10x4 3/4x6 1/2	254	121	885	790	785	710	680	7.0	-
10x5x6 1/2	254	127	940	835	830	755	725	7.2	7.5
10 1/2x5x6 1/2	267	127	1000	890	885	805	770	8.0	-
12x4x8	305	102	835	745	740	670	645	7.6	-
12x4 1/2x8	305	114	970	865	860	780	745	8.8	-
12x5 1/2x8	305	140	1240	1100	1095	995	950	10.8	-
13 1/2x5 1/2x8	343	140	1400	1245	1235	1125	1075	14.1	12.6
14x4 1/2x8	356	114	1085	965	960	870	835	11.6	11.2
14x5x10	356	127	1240	1100	1095	995	955	11.9	-
15x4x11 1/4	381	102	985	875	870	790	755	10.5	-
15x5x11 1/4	381	127	1290	1150	1145	1040	995	12.8	-
16x5x10 1/2	406	127	1400	1245	1240	1125	1075	15.2	14.7
16x6x10 1/2	406	152	1775	1580	1570	1430	1365	18.3	17.7
16x7x10 1/2	406	178	2155	1915	1905	1730	1655	21.4	-
16 1/4x5x11 1/4	413	127	1415	1260	1250	1135	1090	15.1	14.5
16 1/4x6x11 1/4	413	152	1780	1585	1575	1430	1370	18.1	17.4
16 1/4x7x11 1/4	413	178	2150	1915	1900	1730	1655	21.4	20.6
17x5x12 1/8	432	127	1460	1300	1295	1175	1125	15.7	-
18x5x12 1/8	457	127	1525	1355	1350	1225	1175	18.2	17.5
18x6x12 1/8	457	152	1945	1735	1720	1565	1500	22.1	21.0
18x7x12 1/8	457	178	2370	2110	2095	1905	1820	25.2	24.9
18x8x12 1/8	457	203	2790	2485	2470	2245	2145	29.0	28.3
18x9x12 1/8	457	229	3215	2860	2840	2580	2470	-	35.0
21x6x15	533	152	2185	1945	1935	1760	1680	26.6	26.1
21x7x15	533	178	2665	2370	2355	2140	2050	31.1	30.0
21x8x15	533	203	3140	2795	2780	2525	2415	35.7	34.0
21x9x15	533	229	3620	3220	3200	2910	2785	40.3	-
20x5x16	508	127	1620	1440	1430	1300	1245	18.5	-
20x8x16	508	203	2795	2490	2475	2250	2150	29.4	28.5
22x8x16	559	203	3255	2895	2880	2615	2500	37.7	36.0
22x9x16	559	229	3745	3335	3315	3010	2880	46.6	44.1
22x12x16	559	305	5230	4655	4625	4205	4025	63.2	62.0
28x12x22	711	305	6265	5575	5545	5035	4820	83.5	-

# Load & Inflation Pressure Table

## Off -The-Road Slow Speed Service for Loader & Dozers

### Wide Base Radial Ply Tyres

Tyre Size Designation	Air Pressure (kPa)													
	kPa	300	325	350	375	400	425	450	475	500	525	550	575	600
	psi	44	47	51	54	58	62	65	69	73	76	80	83	87
20.5R25 ★	kg	4800	5100	5400	5700	6000	6250	6550	6800	7050	7300	7600	7850	8100
23.5R25 ★		6100	6500	6850	7200	7550	7900	8250	8600	8950	9250	9600	9950	10250
26.5R25 ★		7600	8050	8500	8950	9400	9850	10250	10700	11100	11500	11950	12350	12750
29.5R25 ★		9250	9800	10350	10900	11450	11950	12500	13000	13500	14000	14500	15000	15500

It is permissible to increase inflation pressure up to 100kPa(15psi) above table without increase in load.

Operating Speed (km/h)	Variation in Load Capacity (%)
Static	+60
Creep	+30
4km/h (2.5mph)	+15
10km/h (5mph)	0
15km/h (10mph)	-13
25km/h (15mph)	-20

### Load & Carry operation of front end loaders

Maximum Haul Length	Maximum Speed	Maximum Load
3610m (2000ft)	25km/h (15mph)	Standard load × 0.8
4244m (800ft)	25km/h (15mph)	Standard load × 0.8
576m (250ft)	10km/h (5mph)	Standard load × 1.0

**Note:** When tires are used on for dig and load vehicles in load and carry operations, the haul distance must be limited to 75 meters and maximum speed to 10km/h.

## Off -The-Road Haulage Service for Dump Trucks & Scraper

### Wide Base Radial Ply Tyres

Tyre Size Designation	Air Pressure (kPa)													
	kPa	300	325	350	375	400	425	450	475	500	525	550	575	600
	psi	44	47	51	54	58	62	65	69	73	76	80	83	87
20.5R25 ★★	kg	4800	5100	5400	5700	6000	6250	6550	6800	7050	7300	7600	7850	8100
23.5R25 ★★		6100	6500	6850	7200	7550	7900	8250	8600	8950	9250	9600	9950	10250
26.5R25 ★★		7600	8050	8500	8950	9400	9850	10250	10700	11100	11500	11950	12350	12750
29.5R25 ★★		9250	9800	10350	10900	11450	11950	12500	13000	13500	14000	14500	15000	15500

### Narrow Base Radial Ply Tyres

Tyre Size Designation	Air Pressure (kPa)													
	kPa	450	475	500	525	550	575	600	650	675	700	725	750	775
	psi	65	69	73	76	80	83	87	91	94	98	105	109	112
14.00R25★★★	kg	3850	4050	4300	4550	4750	4950	5200	5400	5600	5800	6050	6250	6450
21.00R35★★		9550	10150	10700	11300	11850	12400	12950	13500	14000	14500	15050	15550	16050
24.00R35★★		12200	12950	13650	14400	15100	15800	16500	17200	17850	18500	19200	19900	20500

Operating Speed (km/h)	Variation in Load Capacity (%)
15km/h 9.3mph	+12
20km/h 12.4mph	+10
25km/h 15.5mph	+8
30km/h 18.6mph	+6
35km/h 21.7mph	+4
40km/h 24.8mph	+3
45km/h 27.9mph	+2
50km/h 31.1mph	0
55km/h 34.2mph	-2
60km/h 37.3mph	-6
65km/h 40.4mph	-12
65km/h>	★

★ : Consult ZC Rubber concerned

# Load & Inflation Pressure Table

## Off-The-Road in Highway Service for Mobile Cranes

CM767 20.5R25 (525/80R25) SI/LI=179E Highway Application

Rim: 17.00/2.0

V (km/h)	Air Pressure (kPa)												
	600	625	650	675	700	725	750	775	800	825	875	900	1000
Creap	19900	20450	21050	21600	22200	22900	23500	24050	24600	25200	26350	26900	28900
2	17700	18200	18700	19200	19700	20350	20850	21350	21850	22400	23400	23900	25700
10	13150	13550	13900	14300	14650	15150	15500	15900	16300	16650	17400		
30	9050	9300	9600	9850	10100	10400	10700	10900	11200	11400	12000		
50	8250	8450	8700	8950	9150	9450	9700	9950	10100	10400	10900		
70	6950	7150	7350	7550	7750	8000	8200	8400					
80	5700	5900	6050	6200	6400	6600	6750	6900					

In case of over 50km/h average speed, never continuously run 2 hours due to heat trouble.

## Load capacities at Various speed for Industrial Vehicles

Recommended by ZC rubber For HARD IMPROVED SURFACE

Size	Li/SS	AP	0 km/h	1 km/h	5 km/h	10 km/h	15 km/h	20 km/h	25 km/h
12.00R20	184A1	1000	10,650	10,150	9,350	9,250	8,700	8,050	7,100
		950	10,200	9,800	9,000	8,900	8,350	7,750	6,850
		850	10,000	9,600	8,800	8,700	8,200	7,600	6,700
23.5R25	212A2	800	28,100	25,000	22,600	21,000	20,200	19,900	19,500
		750	26,800	23,800	21,500	20,000	19,300	18,900	18,600
		700	25,400	22,600	20,400	19,000	18,300	18,000	17,600
26.5R25	218A2	750	33,200	29,500	26,700	24,900	24,000	23,400	23,000
		700	31,500	28,000	25,400	23,600	22,700	22,200	21,900
		650	29,800	26,500	24,000	22,300	21,500	21,000	20,700
16.00R25	200A5	1,000	20,200	17,900	16,200	15,100	14,600	14,200	14,000
		950	19,300	17,200	15,600	14,500	14,000	13,600	13,400
		900	18,700	16,700	15,000	14,000	13,500	13,200	13,000
16.00R25	203A5	1,000	22,300	19,800	18,000	16,700	16,100	15,700	15,500
		950	21,500	19,100	17,300	16,100	15,600	15,200	15,000
		900	20,700	18,400	16,700	15,600	15,000	14,600	14,400

- Note:**
- ① Check maximum air pressure requirements of rims and wheels to ensure ability to accommodate correct air pressure of tyre.
  - ② To obtain the maximum permissible load on lift truck STEERING WHEEL, the above load by 0.8.
  - ③ For speed exceeding 25 km/h, please consult a ZC rubber.

# Radial OTR Range According To Rim

Size	Pattern	TRA Code	Ply Rating	Service Index	Standard Rim	Tread Depth (mm)	Tread Depth (32nd)	Overall Diameter (mm)	Overall Diameter (inch)	Section Width (mm)	Section Width (inch)	Max. Load Capacity (kg)	Max. Load Capacity (lbs)	Cold Inflation Pressure (kPa)	Cold Inflation Pressure (psi)	TT/TL
15.5R25	CB761	L-3	★	169A2	12.00/1.3	26.0	33	1275	50.2	395	15.6	5800	12800	500	73	TL
	CB798	E-3	★★	160B	12.00/1.3	25.0	31	1275	50.2	395	15.6	4500	9900	525	76	TL
		L-3	★★	176A2	12.00/1.3	25.0	31	1275	50.2	395	15.6	7100	15700	650	94	TL
	CB790	L-5	★★	176A2	12.00/1.3	60.0	76	1325	52.2	395	15.6	7100	15700	650	94	TL
17.5R25	CB760	E-3	★★	167B	14.00/1.5	27.0	34	1350	53.1	445	17.5	5450	12000	525	76	TL
		L-3	★★	182A2	14.00/1.5	27.0	34	1350	53.1	445	17.5	7100	15700	500	73	TL
	CB798	E-3	★★	153A8	14.00/1.5	28.0	35	1350	53.1	445	17.5	3650	8050	300	44	TL
		L-3	★★	182A2	14.00/1.5	28.0	35	1350	53.1	445	17.5	8500	18700	650	94	TL
	CB797	L5S	★★	182A2	14.00/1.5	66.0	83	1380	54.3	435	17.1	8500	18700	650	94	TL
		E-3	★★	167B	14.00/1.5	27.0	34	1340	52.8	445	17.5	5450	12000	525	76	TT/TL
	CB386	L-3	★★	182A2	14.00/1.5	27.0	34	1340	52.8	445	17.5	8500	18700	650	94	TT/TL
	CB790	L-5	★★	182A2	14.00/1.5	68.0	86	1400	55.1	445	17.5	8500	18700	650	94	TL
20.5R25	CB760	E-3	★★	177B	17.00/2.0	28.5	36	1490	58.7	520	20.5	7300	16100	525	76	TL
		L-3	★★	193A2	17.00/2.0	28.5	36	1490	58.7	520	20.5	9500	20900	500	73	TL
	CB761	E-3	★★	177B	17.00/2.0	33.0	42	1490	58.7	520	20.5	7300	16100	525	76	TL
		L-3	★★	193A2	17.00/2.0	33.0	42	1490	58.7	520	20.5	9500	20900	500	73	TL
	CB790	L-5	★★	193A2	17.00/2.0	72.0	91	1550	61.0	520	20.5	11500	25400	650	94	TL
	CB798	E-3	★★	177B	17.00/2.0	31.0	39	1490	58.7	520	20.5	4625	10200	300	44	TL
		L-3	★★	193A2	17.00/2.0	31.0	39	1490	58.7	520	20.5	11500	25400	650	94	TL
	CB386	E-3	★★	177B	17.00/2.0	31.0	39	1480	58.3	520	20.5	7300	16100	525	76	TT/TL
23.5R25		L-3	★★	193A2	17.00/2.0	31.0	39	1480	58.3	520	20.5	11500	25400	650	94	TT/TL
	CB760	E-3	★★	185B	19.50/2.5	35.5	45	1615	63.6	595	23.4	9250	20400	525	76	TL
		L-3	★★	201A2	19.50/2.5	35.5	45	1615	63.6	595	23.4	12150	26800	500	73	TL
	CB761	E-3	★★	185B	19.50/2.5	36.0	45	1615	63.6	595	23.4	9250	20400	525	76	TL
		L-3	★★	201A2	19.50/2.5	36.0	45	1615	63.6	595	23.4	12150	26800	500	73	TL
	CB792	E-3	★★	185B	19.50/2.5	38.0	48	1615	63.6	595	23.4	9250	20400	525	76	TL
		L-3	★★	201A2	19.50/2.5	38.0	48	1615	63.6	595	23.4	12150	26800	500	73	TL
	CB763	E-4	★★	185B	19.50/2.5	53.0	67	1675	65.9	595	23.4	9250	20400	525	76	TL
		L-4	★★	201A2	19.50/2.5	53.0	67	1675	65.9	595	23.4	12150	26800	500	73	TL
	CB773	L-5	★★	201A2	19.50/2.5	76.0	96	1675	65.9	595	23.4	14500	32000	650	94	TL
	CB790	L-5	★★	201A2	19.50/2.5	78.0	98	1675	65.9	595	23.4	14500	32000	650	94	TL
	CB798	E-3	★★	185B	19.50/2.5	34.0	43	1615	63.6	595	23.4	6000	13230	300	44	TL
		L-3	★★	201A2	19.50/2.5	34.0	43	1615	63.6	595	23.4	14500	32000	650	94	TL
	CB386	E-3	★★	185B	19.50/2.5	34.0	43	1615	63.6	595	23.4	9250	20400	525	76	TT/TL
		L-3	★★	201A2	19.50/2.5	34.0	43	1615	63.6	595	23.4	14500	32000	650	94	TT/TL
	26.5R25	CB761	E-3	★★	193B	22.00/3.0	37.0	47	1750	68.9	675	26.6	11500	25400	525	76
		L-3	★★	209A2	22.00/3.0	37.0	47	1750	68.9	675	26.6	15000	33100	500	73	TL
CB792		E-3	★★	193B	22.00/3.0	40.0	50	1750	68.9	675	26.6	11500	25400	525	76	TL
		L-3	★★	209A2	22.00/3.0	40.0	50	1750	68.9	675	26.6	15000	33100	500	73	TL
CB763		E-4	★★	193B	22.00/3.0	56.0	71	1800	70.9	675	26.6	11500	25400	525	76	TL
		L-4	★★	209A2	22.00/3.0	56.0	71	1800	70.9	675	26.6	15000	33100	500	73	TL
CB773		L-5	★★	209A2	22.00/3.0	86.0	108	1800	70.9	675	26.6	18500	40800	650	94	TL
CB790		L-5	★★	209A2	22.00/3.0	88.0	111	1800	70.9	675	26.6	18500	40800	650	94	TL
CB797		L5S	★★	209A2	22.00/3.0	94.0	118	1788	70.4	660	26.0	18500	40800	650	94	TL
CB386		E-3	★★	193B	22.00/3.0	37.0	47	1750	68.9	675	26.6	11500	25400	525	76	TT/TL
		L-3	★★	209A2	22.00/3.0	37.0	47	1750	68.9	675	26.6	18500	40800	650	94	TT/TL
29.5R25		CB761	E-3	★★	200B	25.00/3.5	43.0	54	1875	73.8	750	29.5	14000	30900	525	76
		L-3	★★	216A2	25.00/3.5	43.0	54	1875	73.8	750	29.5	18000	39700	500	73	TL
	CB792	E-3	★★	200B	25.00/3.5	44.0	55	1875	73.8	750	29.5	14000	30900	525	76	TL
		L-3	★★	216A2	25.00/3.5	44.0	55	1875	73.8	750	29.5	18000	39700	500	73	TL
	CB763	E-4	★★	200B	25.00/3.5	59.0	74	1875	73.8	750	29.5	14000	30900	525	76	TL
		L-4	★★	216A2	25.00/3.5	59.0	74	1875	73.8	750	29.5	18000	39700	500	73	TL
	CB790	L-5	★★	216A2	25.00/3.5	96.0	121	1920	75.6	750	29.5	22400	49400	650	94	TL
CB773	L-5	★★	216A2	25.00/3.5	94.0	118	1920	75.6	750	29.5	22400	49400	650	94	TL	
365/70R18	CB796	-	-	146A2	11.00	18.0	23	969	38.1	360	14.2	3000	6610	375	54	TL
		-	-	135B	11.00	18.0	23	969	38.1	360	14.2	2180	4800	375	54	TL
405/70R18	CB796	-	-	153A2	13.00	19.0	24	1029	40.5	400	15.7	3650	8050	375	54	TL
		-	-	141B	13.00	19.0	24	1029	40.5	400	15.7	2575	5675	375	54	TL
405/70R20	CB796	-	-	155A2	13.00	19.0	24	1080	42.5	400	15.7	3875	8540	375	54	TL
		-	-	143B	13.00	19.0	24	1080	42.5	400	15.7	2725	6005	375	54	TL
395/85R20(14.00R20)	CM770	-	20PR	170F	10.00	17.5	22	1180	46.5	386	15.2	6000	13230	900	130	TL
13.00R24	CB776	G2	★	146A8	8.00TG	25.0	31	1280	50.4	335	13.2	3000	6600	375	54	TL
385/95R24(14.00R24)	CM770	-	★★★	170F/170E	10.00/1.5	24.0	30	1369	53.9	379	14.91	6000	13230	900	131	TT
10.00R20	CB382	PORTUSE	-	166A5	7.50	35.0	44	1062	41.8	278	10.9	5300	11700	1000	145	TL
12.00R20	CB382	PORTUSE	-	176A5	8.50	40.0	50	1136	44.7	315	12.4	7100	15700	1000	145	TL
12.00R24	CB382	PORTUSE	-	178A5	8.50	40.0	50	1238	48.7	312	12.3	7500	16500	1000	145	TL
14.00R24	CB382	PORTUSE	-	193A5	10.00/2.0	64.0	81	1418	55.8	375	14.8	11500	25400	1000	145	TL
	CB765	E-3	★★★★	169B	10.00/2.0	27.0	34	1370	53.9	375	14.8	5800	12800	700	101	TT
	CB776	G-2	★	153A8	8.00TG	26.0	33	1350	53.1	360	14.2	3650	8050	375	54	TL
	CB798	G-2	★	153A8	8.00TG	24.0	30	1350	53.1	360	14.2	3650	8050	375	54	TL
16.00R24	CB776	G-2	★	161A8	10.00VA	29.0	37	1460	57.5	425	16.7	4625	10200	375	54	TL
13.00R25	CB765	E-3	★★★★	163B	10.00	27.0	34	1300	51.2	350	13.8	4875	10700	700	102	TT
385/95R25(14.00R25)	CM770	-	★★★★	170F/170E	10.00/1.5	24.0	30	1369	53.9	379	14.9	6000	13230	900	131	TL

# Radial OTR Range According To Rim

Size	Pattern	TRA Code	Ply Rating	Service Index	Standard Rim	Tread Depth (mm)	Tread Depth (32nd)	Overall Diameter (mm)	Overall Diameter (inch)	Section Width (mm)	Section Width (inch)	Max. Load Capacity (kg)	Max. Load Capacity (lbs)	Cold Inflation Pressure (kPa)	Cold Inflation Pressure (psi)	TT/TL
14.00R25	CB771	E-4	★★★	169B	10.00	38.0	48	1420	55.9	375	14.8	5800	12800	700	101	TT/TL
	CB765	E-3	★★★	169B	10.00	27.0	34	1370	53.9	375	14.8	5800	12800	700	101	TT
445/95R25(16.00R25)	CM770	-	★★★	174F/177E	11.25/2.0	28.0	35	1481	58.3	435	17.1	6700	14800	900	131	TL
16.00R25	CR795	STRADDLE	★★	202A7	11.25/2.0	48.0	60	1550	61.0	430	16.9	15000	33100	1000	145	TT/T
	CB771	E-4	★★	177B	11.25/2.0	44.0	55	1550	61.0	430	16.9	7300	16100	650	94	TL
18.00R25	CB771	E-4	★★	185B	13.00/2.5	51.0	64	1675	65.9	500	19.7	9250	20400	700	102	TL
	CB797	L5S	★★★	206A2	13.00/2.5	82.0	103	1664	65.5	478	18.8	17000	37500	900	131	TL
525/80R25(20.5R25)	CM767	-	★★★	176F/179E	17.00/2.0	28.5	36	1490	58.7	520	20.5	7750	17100	700	102	TL
18.00R33	CB771	E-4	★★	191B	13.00/2.5	54.0	68	1875	73.8	500	19.7	10900	24000	700	102	TL
21.00R33	CB771	E-4	★★	200B	15.00/3.0	54.0	68	2000	78.7	570	22.4	14000	30900	700	102	TL
21.00R35	CB771	E-4	★★	201B	15.00/3.0	61.0	77	2050	80.7	570	22.4	14500	32000	700	102	TL
	CB761	E-3	★★	201B	15.00/3.0	44.0	55	2005	78.9	570	22.4	14500	32000	700	102	TL
24.00R35	CB765	E-4	★★	209B	17.00/3.5	57.0	72	2175	85.6	655	25.8	18500	40800	700	102	TL
	CB771	E-4	★★	209B	17.00/3.5	65.0	82	2175	85.6	655	25.8	18500	40800	700	102	TL
27.00R49	CB791	E-4	★★	223B	19.50/4.0	72.0	91	2700	106.3	735	28.9	27250	60000	700	102	TL
750*65R25	CB763	E-4	★★	190B	24.00/3.0	53.0	67	1610	63.4	755	29.7	10600	23400	475	69	TL
		L-4	★★	209A2	24.00/3.0	53.0	67	1610	63.4	755	29.7	18500	40800	625	91	TL
875/65R29	CB763	E-4	★★	203B	28.00/3.5	59.0	74	1875	73.8	880	34.6	15500	34200	475	69	TL
	CB763	L-4	★★	221A2	28.00/3.5	59.0	74	1875	73.8	880	34.6	25700	56800	625	91	TL
280/75R22.5	CR380	-	-	168A8	8.25	32.0	40	992	39.1	280	11.0	5600	12300	1000	145	TL
310/80R22.5	CR380	-	-	175A8	9	32.0	40	1078	42.4	300	11.8	6900	15200	1000	145	TL
650/65R25	CB798	E-3	★★	180B	19.50/2.5	38.0	48	1490	58.7	640	25.2	8000	17600	425	62	TL
		L-3	★★	200A2	19.50/2.5	38.0	48	1490	58.7	640	25.2	14000	30900	625	91	TL
	CB792	E-3	★★	180B	19.50/2.5	42.0	53	1490	58.7	640	25.2	8000	17600	425	62	TL
		L-3	★★	200A2	19.50/2.5	42.0	53	1490	58.7	640	25.2	14000	30900	625	91	TL



ZHONGCE RUBBER GROUP CO., LTD.



[zc-rubber.com](http://zc-rubber.com)



[facebook.com/zcrubber](https://facebook.com/zcrubber)



[twitter.com/zc\\_rubber](https://twitter.com/zc_rubber)



[linkedin.com/company/zcrubber](https://linkedin.com/company/zcrubber)